

Service Information

2001-02-25

Vacuum cleaner
HR 8582/B

DAP312

Domestic Appliances and Personal Care

Use Service Manual 4322 277 00261

In vacuum cleaners type HR 8582 version /A, the cordwinder with a round cord has been replaced with a **new cord winder with a flat cord**. As a result, the version indication has been **changed to /B**.

Replacement of a cord:

The cords have a standard length and, depending on the cord length required for the appliance, the cord must be shortened.

If the cord comes without AMP clamps, it can be soldered onto the terminals.

If pos. 81 is replaced, shaft **A** must be lubricated with silicone grease (A). This grease **may not** be used on terminals (85) or on conductors (84).

Spares:

23	brake tyre	4322 001 72360	86	Argentina	L= 9.3 m	4322 006 01440
81	reel half spring unit (l=9m)	4322 009 07940		Australia	L= 9.3 m	4322 006 01760
84	reel half contact unit	4322 009 07950	87	Taiwan	L= 6.3 m	4322 006 01680
85	contact ring plate	4322 009 07960	88	U.K. / H.K.	L= 9.3 m	4322 006 01720
A	silicon grease for the shaft	5322 390 20011	89	Euro 4.8mm pins	L= 9.3 m	4322 006 01410
B	screw 3.5 x 12 / T10	4322 002 82550	90	Swiss	L= 9.3 m	4322 006 01670
			91	Italy	L= 9.3 m	4322 006 01460

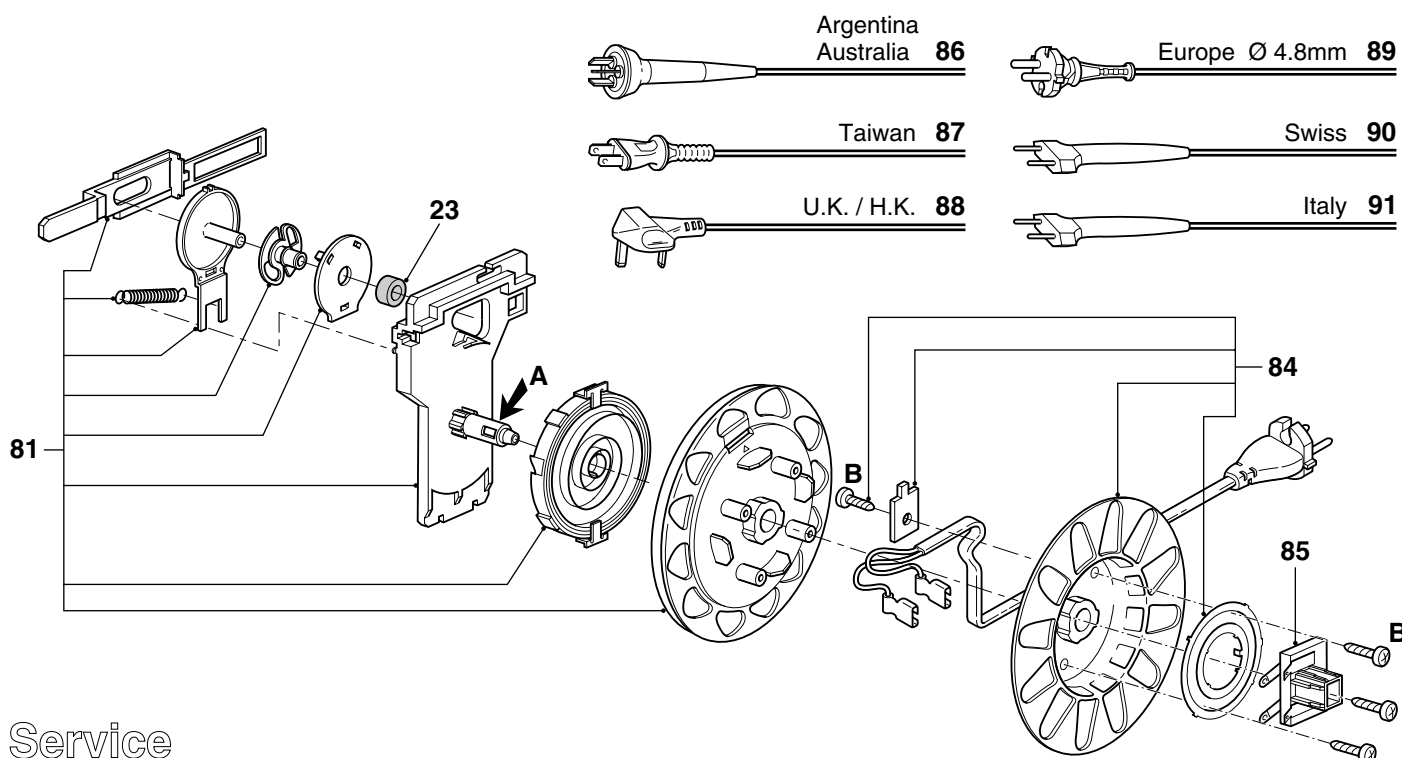

Service
Service
Service

4322 277 00508

DAP1422