



Service Manual

Washing machine

Frontloader

MAF 6512 AAW

Model Version	MAF 6512 AAW 8521 203 53000	Page
	Technical data	2 - 4
	Spare part list	5
	Exploded view	6 - 7
	Wiring diagram	8
	Circuit diagram	9
	Program chart	10 - 20
	Text/Legend	21 - 24
	Family	DOMINO



R o H S

Technical data**Dimensions**

Height	85	cm
Width	59.5	cm
Depth	59	cm

Weight

Net	72	kg
With packing	74	kg

Main connection

Voltage	230	V ± 10%
Frequency	50	Hz
Power consumption	~2.3	kW
Fuse rating	10	A

Drum

Volume	53	l
Wash spin	54	rpm
Ramp spin	110	rpm
Speed spinning max.	1200	rpm

Capacity of dry laundry

Cotton 70/95 °C	6.5	kg
Cotton 40/60 °C	6.5	kg
Cotton 20/30 °C	5	kg
Super Eco	6	kg
Synthetics	2.5	kg
Daily	3	kg
Quick wash	3	kg
Delicate	1.5	kg
Wool	1	kg
Hand wash	1	kg
Rinse & Spin	6.5	kg
Rinse & Gentle Spin	1	kg
Spin	6.5	kg
Gentle Spin	1	kg

Pressostat**Level1**

Switching point	50 ± 5	mmWc
Reset	25 ± 5	mmWc

Overflow

Switching point	300 ± 20	mmWc
-----------------	----------	------

Nominal currents

Contacts		
11 - 12	4 (4)	A
11 - 14	16 (4)	A
11 - 16	1 (1)	A

Door lock

Kind of switch	Switch with PTC heater of bimetal	
Type	DA	
Nominal voltage	230	V
Nominal current:		
Contact 4 - 5	16 (4)	A
Lock time	≤6"	
Unlock time	65/85"	

Heating element

Kind of heating	Tubular heating element with NTC - sensor	
Nominal voltage	240 +10%, -15% V	
Nominal power	2050	W ± 5%
Resistance (20 °C)	23.9	Ω ± 5%
Thermo-fuse (switch OFF temperature)	152	°C
Leakage current (<99 °C)	<0.8	mA

NTC sensor

Resistance NTC:		
0 °C	35.9	kΩ ± 5.8%
30 °C	9.8	kΩ ± 3.7%
40 °C	6.6	kΩ ± 3.1%
50 °C	4.6	kΩ ± 2.6%
60 °C	3.2	kΩ ± 2.0%
70 °C	2.3	kΩ ± 2.5%
95 °C	1.1	kΩ ± 3.7%

Inlet valve cold fill

Kind of valve	1-inlet, 2-outlet valve for cold water, Connection in RAST 2.5	
Water temperature		
25 °C	ON	100 %
90 °C	ON	3'
	OUT	5'

Rated flow (1.5 - 5 bar)	8	l/min
Pressure range	0.3 - 10	bar
Nominal voltage	220 - 240	V
Frequency	50	Hz
Starting voltage	<6bar	160 V
	6-10bar	170 V
Nominal current	35	mA
Nominal power	6	W
Nominal resistance (20 °C)	3.8	kΩ ± 10%

Technical data

Inlet valve hot fill

Water temperature			
25 °C	ON	100 %	
90 °C	ON	3'	
	OUT	5'	
Rated flow:			
0.3 - 1.0 bar	8 -15%, +50%	l/min	
1.0 - 1.5 bar	8	l/min ± 8%	
1.5 - 5.0 bar	8	l/min ± 5%	
5.0 - 10 bar	8	l/min ± 8%	
Pressure range	0.3 - 10	bar	
Nominal voltage	220 - 240	V	
Frequency	50	Hz	
Starting voltage	<6bar	160	V
	6-10bar	170	V
Nominal current	35	mA	
Nominal power	6	W	
Nominal resistance (20 °C)	3.8	kΩ ± 10%	

Drain pump (synchronous)

Nominal voltage	220 - 240	V
Nominal current	0.3/0.5	A
Nominal consumption	30	W
Frequency	50	Hz
Resistor (coil)	160	Ω
Overheating protection	no	
Capacity (0.5 - 1 m height)	14 ± 2	l/min
Rotation speed	3000	prm

Motor

Type	MCA 45/64 - 148/ WHE 7 i = 1:13.1
------	---

Resistance contacts (20 °C)

Stator (full field)	6 - 7	68.70	Ω ± 7%
Stator (tapp. field)	4 - 5	2.15	Ω ± 7%
Rotor	5 - 6	1.46	Ω ± 7%
Tachogenerator	5 - 7	0.65	Ω ± 7%

Radio interference supression

Type	ISKRA KPL 3524
Nominal voltage	250 V
Nominal current	12.5 A
Frequency	50/60 ± 3 Hz
Nominal capacity	470 nF X1 + 2 x 22 nF Y ± 20%
Nominal inductance	2 x 470 mH-30+50%
Nominal resistance	680 kΩ ± 5%
Derivation current (u = 250 V AC)	≤ 4.15 (2 x 2.075) mA

Electronic complete

Type	DOMINO
Basic	4619 714 04116
Programmed	4619 744 87341
Nominal voltage	230 V
Frequency	50 Hz
Positions	18

Ambient temperature	up to 70 °C
Storage temperature	up to 85 °C

Output

Motor	M7.6 - DSS3.2	>40 V
Aquastop	AQ2.2 - DSS3.2	230 V
In pump step	AQ2.1 - DSS3.3	230 V
NTC	Not measurable	
Pump	DP2.1 - DP2.2	230 V
Doorlock	DSS3.1 - DSS3.3	230 V
Pressostat	E4 - E2	230 V
- empty	PR2.1 - E2	230 V
- full	PR2.2 - E2	230 V
Valve (Rast 2.5)	V2.1 - V2.2	>170 V
Options	Not measurable	

Option module + Display

Type	DOMINO E5
------	-----------

Program

1.	Cotton 70/95 °C
2.	Cotton 40/60 °C
3.	Cotton 20/30 °C
4.	Super Eco
5.	Synthetic
6.	Daily load
7.	Quick wash
8.	Delicate
9.	Wool
10.	Hand wash
11.	Rinse & spin
12.	Rinse & Gentle spin
13.	Spin
14.	Gentle spin
15.	Drain

Technical data

Push button switch

Favorite	FAV
Reset	Reset
Start	SRT
Switch start delay	SDT
Switch temperature	TEMP
Switch Pre wash	SPW
Switch Rinse hold	SRH
Switch Rinse intensive	SRI
Switch Easy ironing	SEI
Switch Spin reduction (1160, 780, 440, 95, 0)	SSR

Spare part list

Model **MAF6512AAW**
Service No. **852120353000**
Version **852120353000**

Pos. No.	12NC Code	Description
001 0	4812 440 11538	Cabinet
002 0	4812 440 11131	Flap square EBL
011 0	4812 462 48421	Adjust. foot
021 0	4812 440 11639	Front EBL
024 0	4812 440 11544	Panel rear
025 0	4812 440 11472	Support control board
030 0	4812 440 11691	Table top EBL
040 0	4812 417 18787	Hinge
050 0	4812 440 89097	Plinth EBL
061 0	4812 466 88936	Counter weight upper
061 1	4812 466 88607	Counter weight front, bottom
061 2	4812 310 39135	Mounting kit weight top
065 2	4812 310 19136	Insulation
081 0	4812 529 18038	Shock absorber until 1200
084 0	4812 466 58001	Silent bloc
086 2	4812 401 18412	Stopper
110 0	4812 498 18675	Handle door EBL BK, galv.
130 0	4812 417 28047	Plate Door lock
130 1	4812 417 28048	Plate Doorlock Lower
131 0	4812 417 28046	Lock Door
131 1	4812 417 28045	Pin Door Lock
131 2	4812 492 58022	Spring Door Lock
131 3	4812 492 58056	Spring Door Lock Child
135 1	4812 498 18262	Knob Door safety GW
135 2	4812 491 48004	Spring Door Safety
135 3	4812 290 68153	Holder adjust. Door Safety
140 0	4812 450 59812	Door glass DELTA EUREKA
143 0	4812 440 11453	Glassdoor frame EBL BK
144 0	4812 440 11575	Frame door glas
144 3	4812 502 18669	Screw 4.0x12
191 0	4812 460 68617	Door bellow
191 1	4812 492 18017	Strap
191 2	4819 530 58059	Ring
200 1	4812 418 18672	Tub 48L FRONT
200 2	4812 418 18593	Tub 48 l rear
200 4	4812 290 88054	Clamp for tub
220 0	4812 418 18585	Drum 50LT.1200
271 0	4812 358 18056	V-ribbed belt WH 1250 J5
272 0	4812 528 58041	Pulley 298/5 arm
272 3	4812 505 18371	Nut M 12
292 0	4812 530 58101	Gasket Tub
301 0	4812 453 10805	Control panel + handle drawer
331 0	4812 414 58338	Knob timer BK 07 HIGH
331 3	4812 414 58307	Knob timer ring, bush spring
331 4	4812 414 58337	Knob timer ring, silverBK
332 0	4812 410 29561	Push button SET-BGW-BK,MID
333 0	4812 410 29558	Push button 2OPT.BK-HIGH
333 1	4812 410 29559	Push button 1OPT.BK-HIGH
400 0	4812 361 58376	Motor MCA52WHE0
400 1	4812 502 18737	Screw 8x38
409 0	4812 362 48004	Brush,carbon motor CESET
421 0	4812 121 18285	Interf.filter 1,00 µ F
430 0	4812 360 18599	Pump COD HIGH MICROBAN
451 0	4812 259 28923	Heating element 240 V with NTC
480 0	4812 321 78351	Cable DOMINO-MOT 7

Pos. No.	12NC Code	Description
490 0	4812 310 18404	Kit cable, mains 5m 3x1,5
491 0	4812 321 28367	Strain relief
491 1	4812 502 38152	Screw 4.8x19
521 0	4812 214 70543	Control unit DOMINO, programmed
521 0	4812 214 70544	Control unit DOMINO, basic
571 0	4812 271 28558	Valve magnet 1 inlet, 2 outlets
573 0	4812 271 28591	Valve magnet INLET,HOT
581 0	4812 271 28585	Pressostat 50/25 INVENS.
620 0	4812 239 58075	Module E5-BW DOM HR
630 0	4812 280 58048	Door lock 3 tab
653 0	4812 134 48392	Light guide PROG.FLOW-BW-BK
653 1	4812 134 48391	Light guide SINGLE-BK-HIGH
653 2	4812 134 48397	Light guide 6opt-BK-BIGWIN
691 0	4812 282 19485	Sensor NTC SC1,OMEGA3
701 0	4812 530 28781	Hose inlet 3.8 m (Eltek)
701 0	4819 530 28926	Hose inlet 2.5 m (Eltek)
701 1	4819 466 69704	Gasket and filter
702 0	4812 530 29405	Hose valve-dispenser
702 1	4812 530 29488	Hose valve-disp-hot
707 5	4812 526 48035	Nozzle warm
708 1	4812 530 48143	Bend
711 0	4812 418 68435	Dispenser BOX,MICROBAN,HOTFIL
712 0	4812 418 68415	Drawer
713 0	4812 418 68382	Safety device drawer
718 0	4812 418 89085	Siphon
718 1	4812 526 48252	Separator
753 1	4819 418 68234	Chamber,air
754 0	4812 530 28826	Drainhose
754 1	4812 530 28832	Lock eco
754 2	4812 530 29352	Flange eco
760 0	4812 480 58385	Cover pump
781 0	4812 530 29438	Hose draining COD
782 0	4812 530 28827	Hose Pressostat
794 2	4812 401 18549	Clamp hose
794 5	4812 530 58098	Gasket Airtrap
900 0	4812 441 38021	Holder hose outlet
900 1	4812 290 88086	Bracket
900 2	4812 290 88077	Cable clamp
900 3	4812 401 18446	Cable clamp
900 4	4812 401 18414	Clamp hose
900 5	4819 401 18529	Clamp hose
900 6	4812 401 18444	Support Heatingelement
900 7	4812 256 98031	Holder pressostat
900 9	4812 255 18286	Holder Hose outlet left
903 0	4812 401 18834	Clamp hose fixation int.
910 1	4812 502 48344	Screw
910 5	4812 502 18516	Screw 4,2 x 13
930 0	4819 492 38139	Spring Suspension
941 0	4812 520 28004	Bearing,ball 6206
941 1	4812 520 28066	Bearing,ball 6204
953 0	4812 530 58099	Shaft seal 1200
961 0	4819 532 68829	Spacer
965 0	4812 466 68545	Cover BK/WH
993 0	4819 530 29028	Bow
993 3	4812 395 58004	Tool

Exploded view

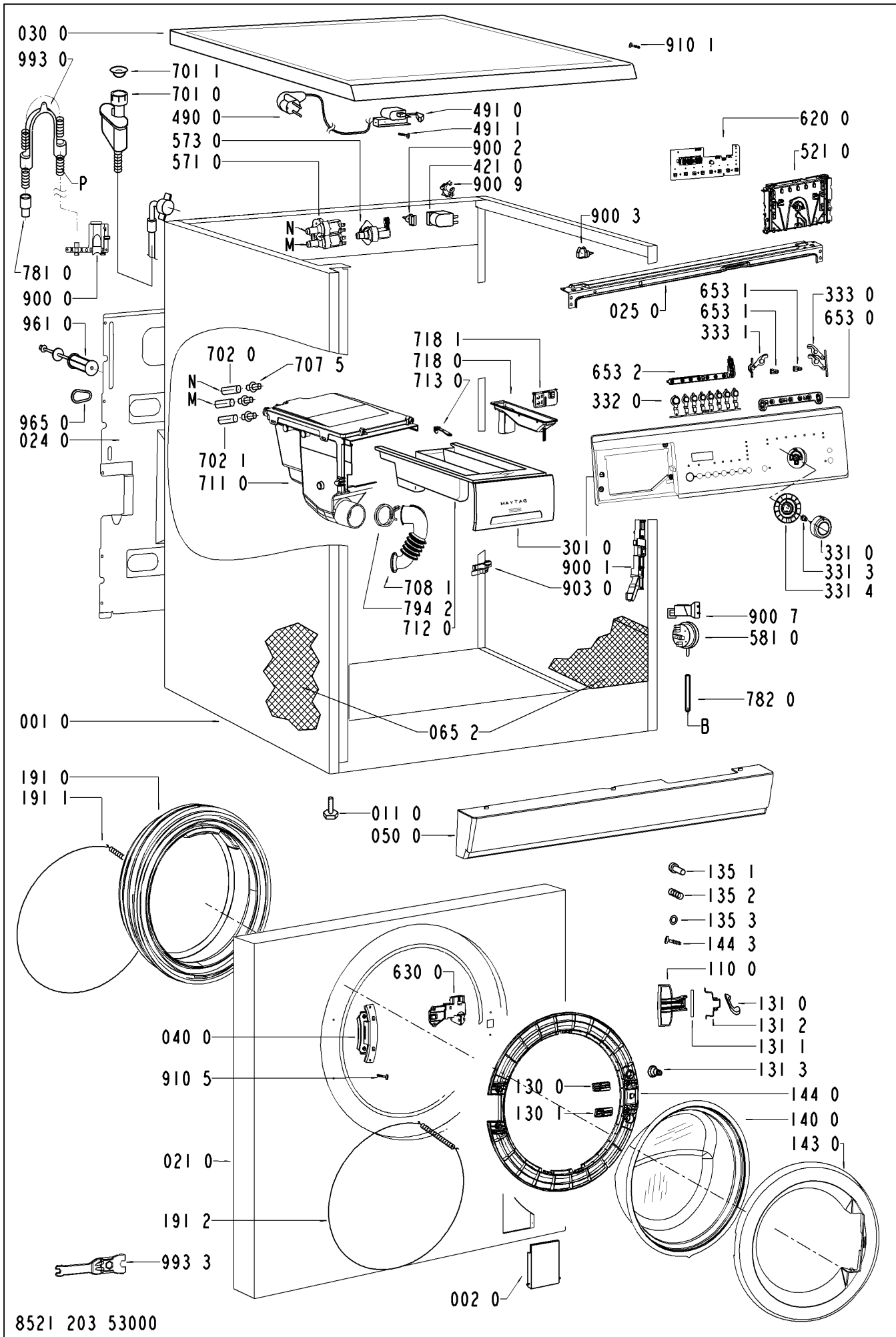

Exploded view

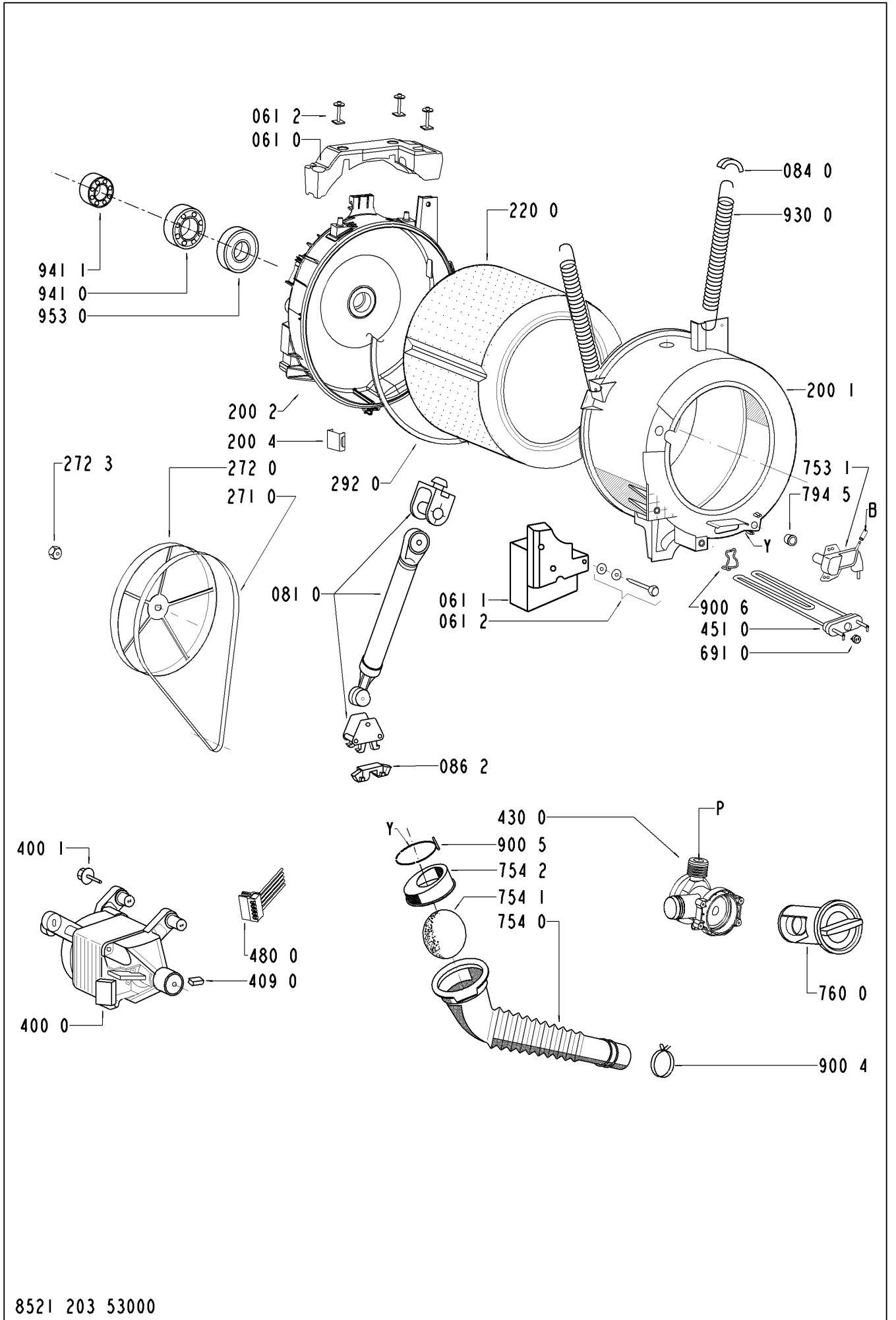

Wiring diagram

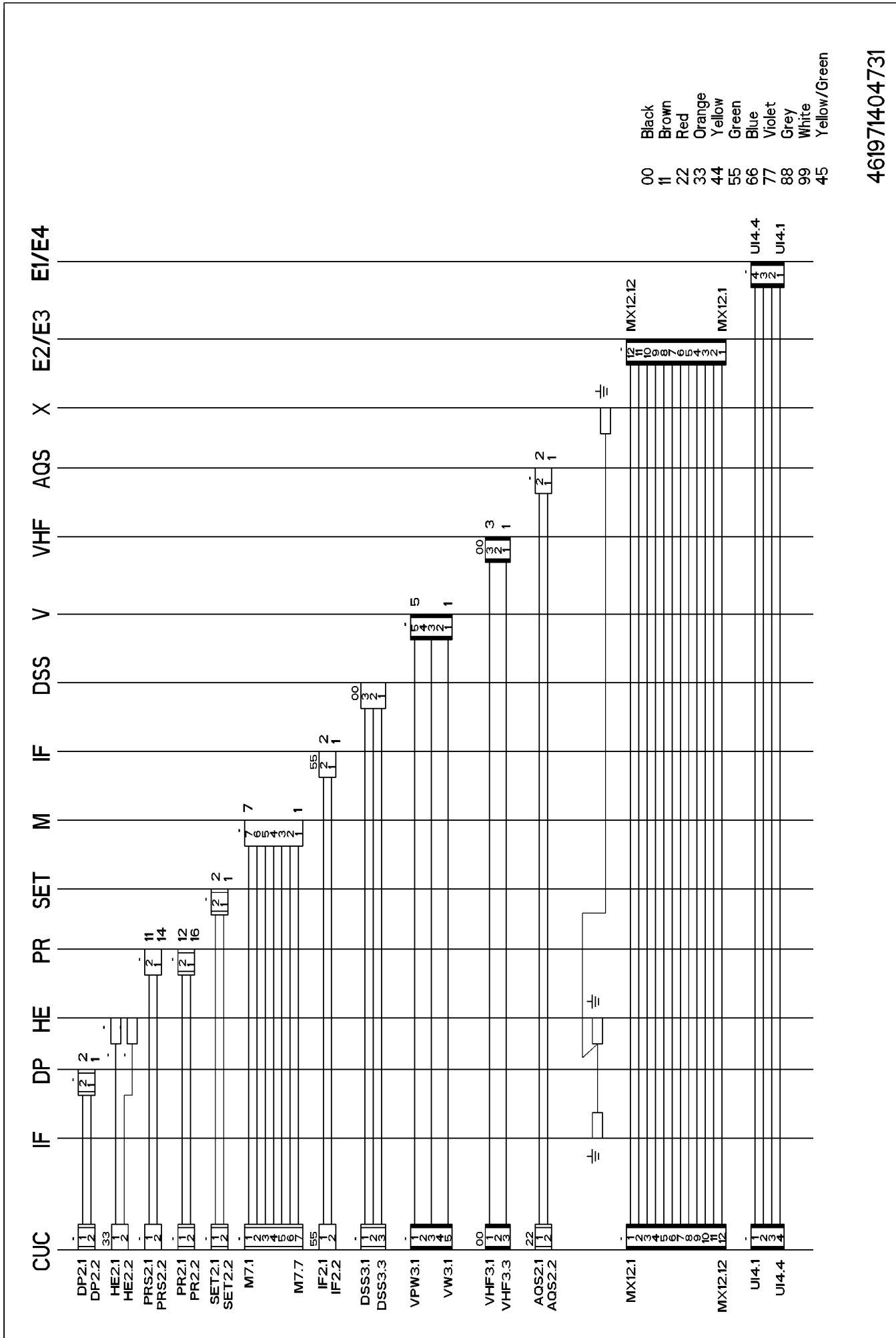

Circuit diagram

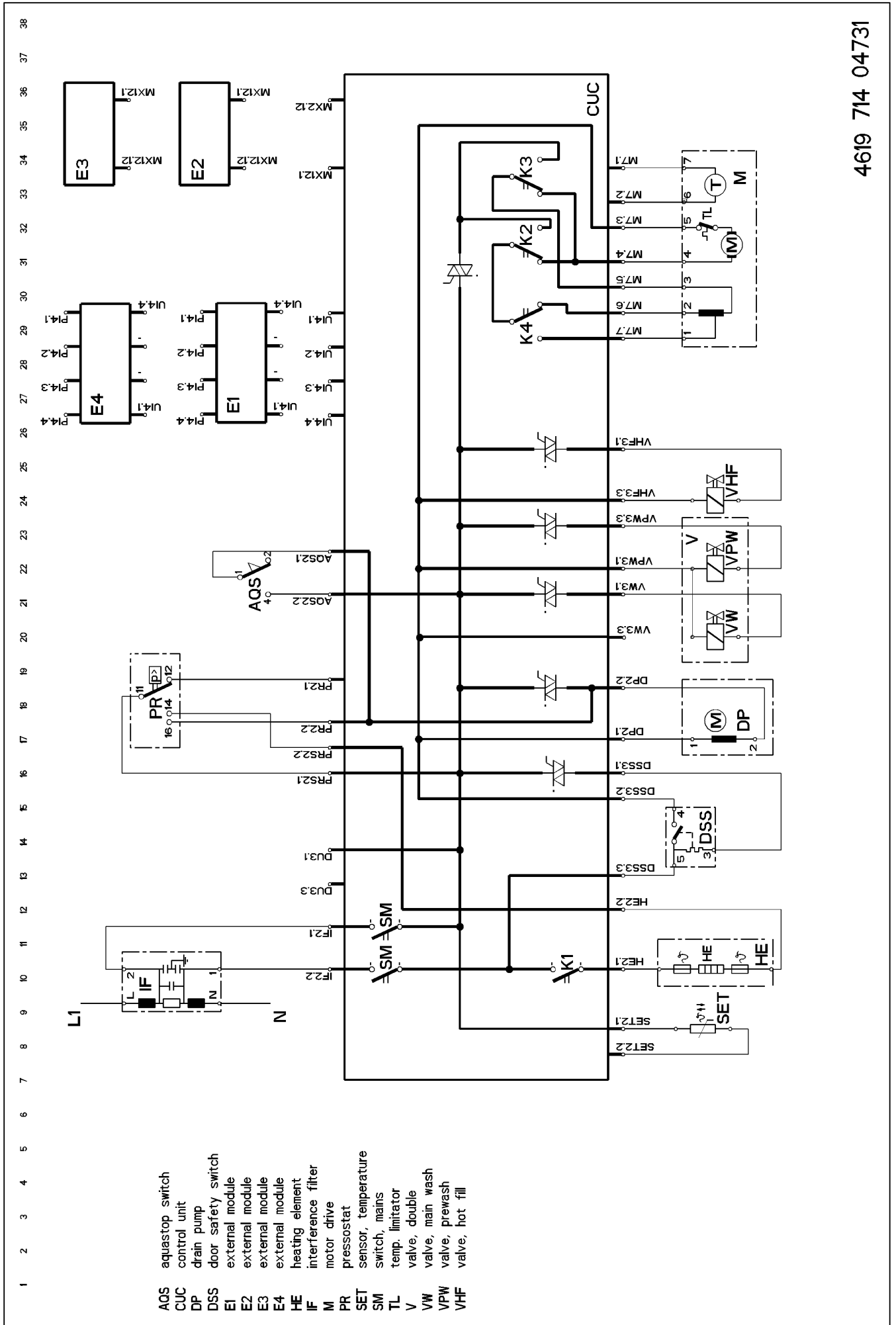

4619 714 04731

Program chart

4619 714 14471

Delta Domino Wash Cycle of Cotton 50°C - 95°C, Antibacterial, Extra Care

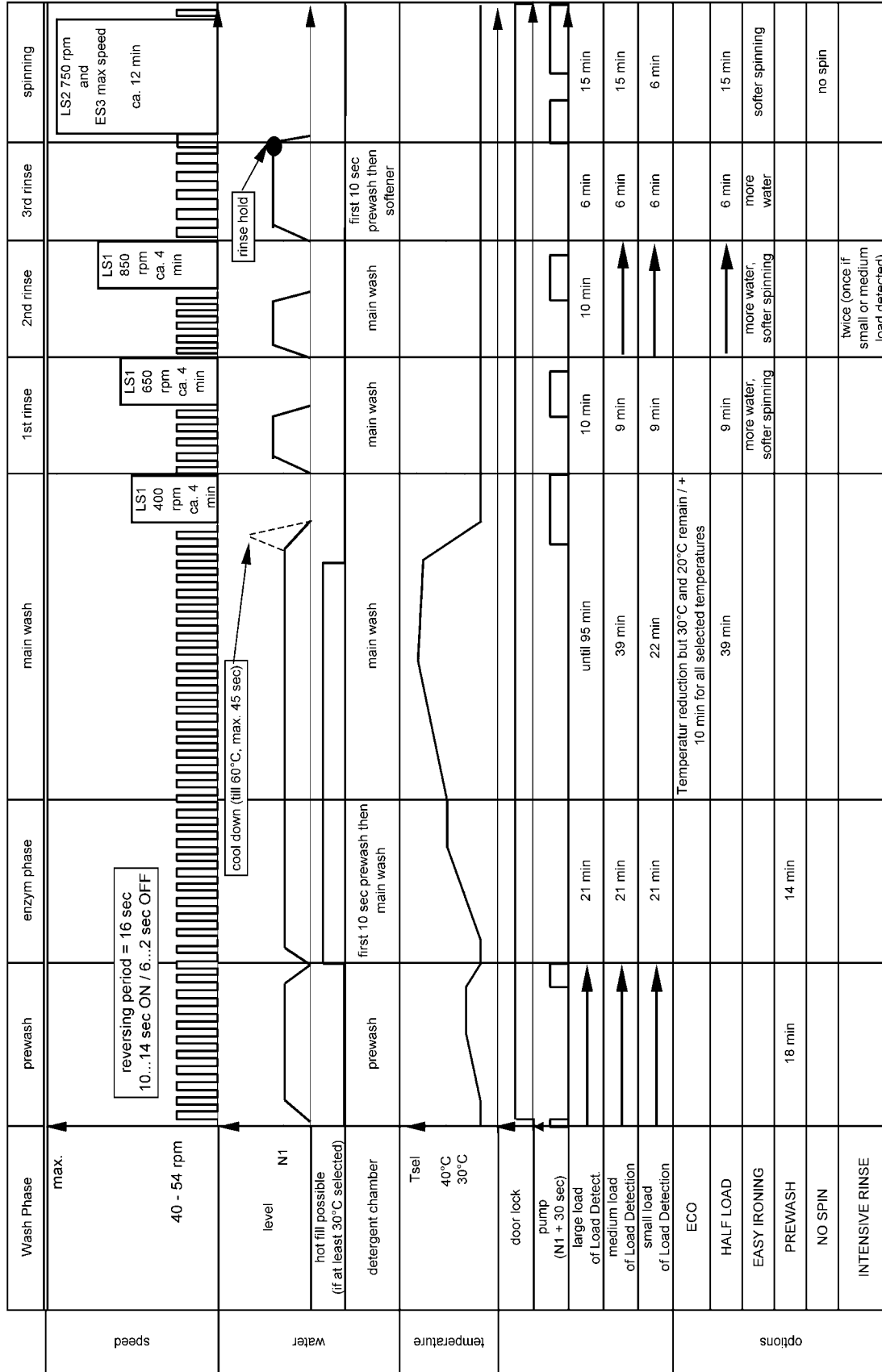

Extra Care: Cotton 60°C + ECO is as default programmed

Program chart

4619 714 14471

Delta Domino Wash Cycle of Cotton max. 40°C, Jeans, Baby

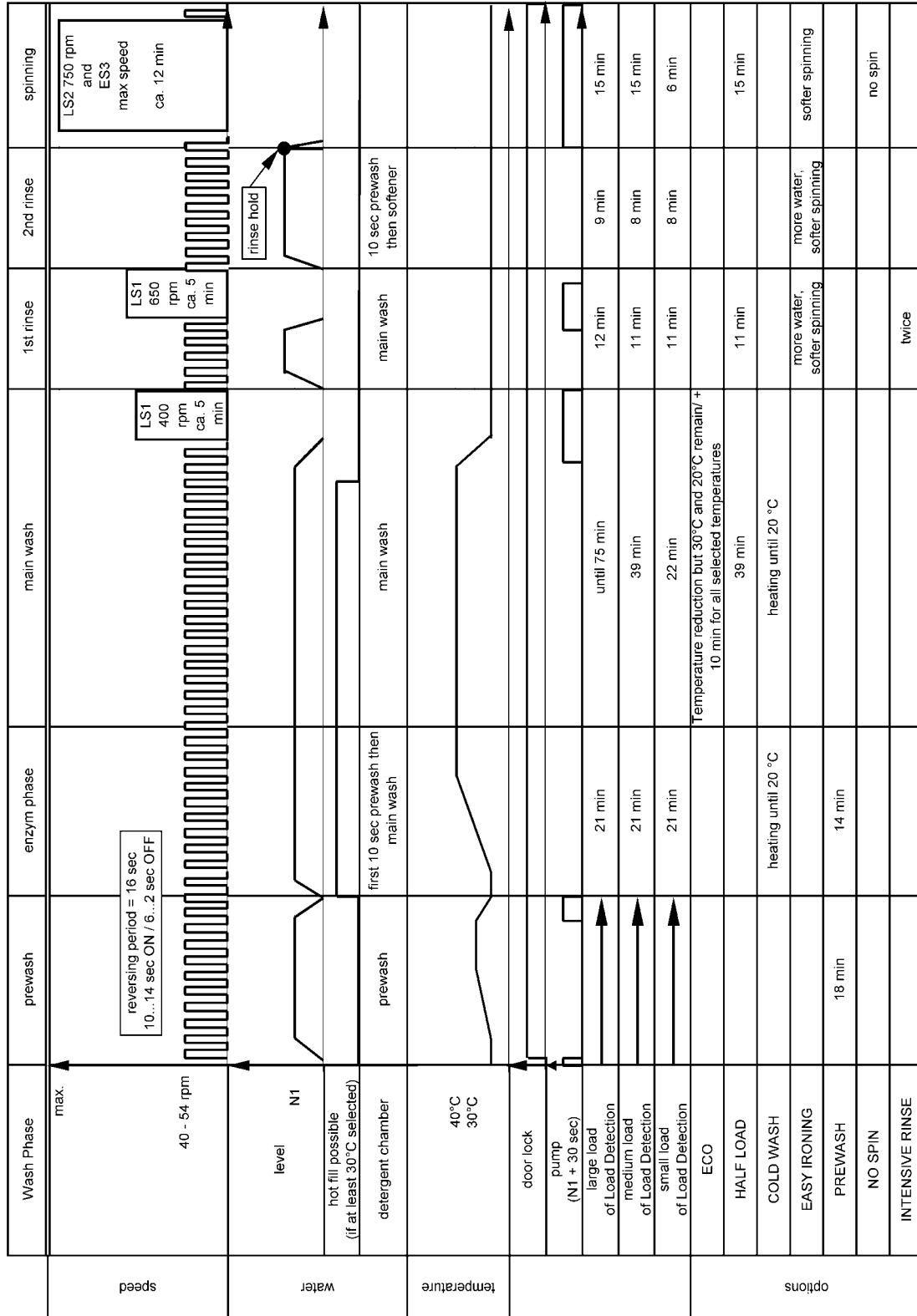

Jeans, Baby: Cotton 40 °C plus intensive rinse is as default programmed, easy ironing and intensive rinse are not selectable.
The option LED of intensive rinse doesn't light.

Program chart

4619 714 14471

Delta Domino Wash Cycle of Synthetic, Sport

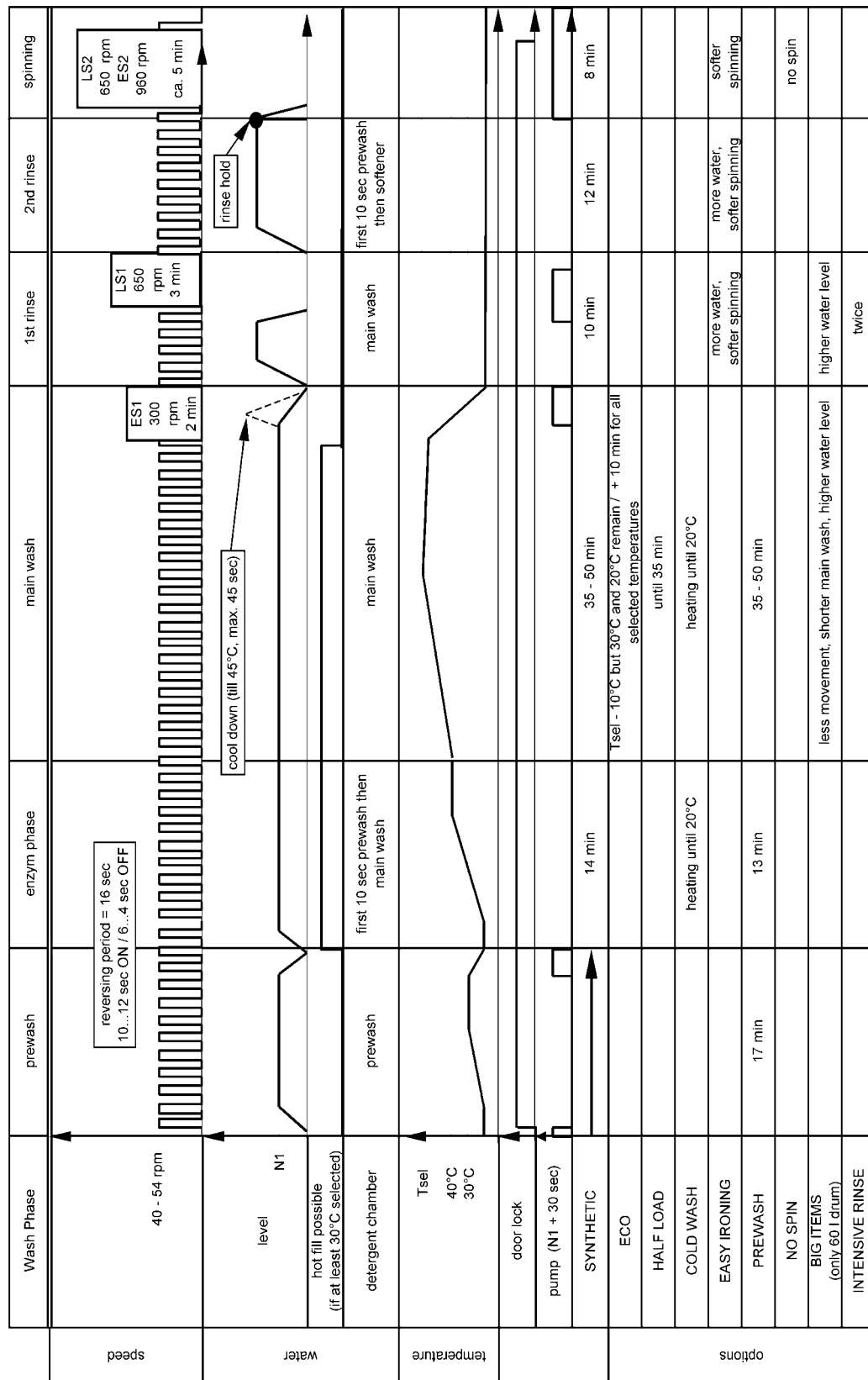

Sport: Synthetic 30°C plus Prewash option is as default programmed, prewash and eco are not selectable
 The option LED of prewash is off after selecting the cycle but after program start the program sequence lamp for prewash lights up.

Program chart

4619 714 14471

Delta Domino Wash Cycle of DELICATE

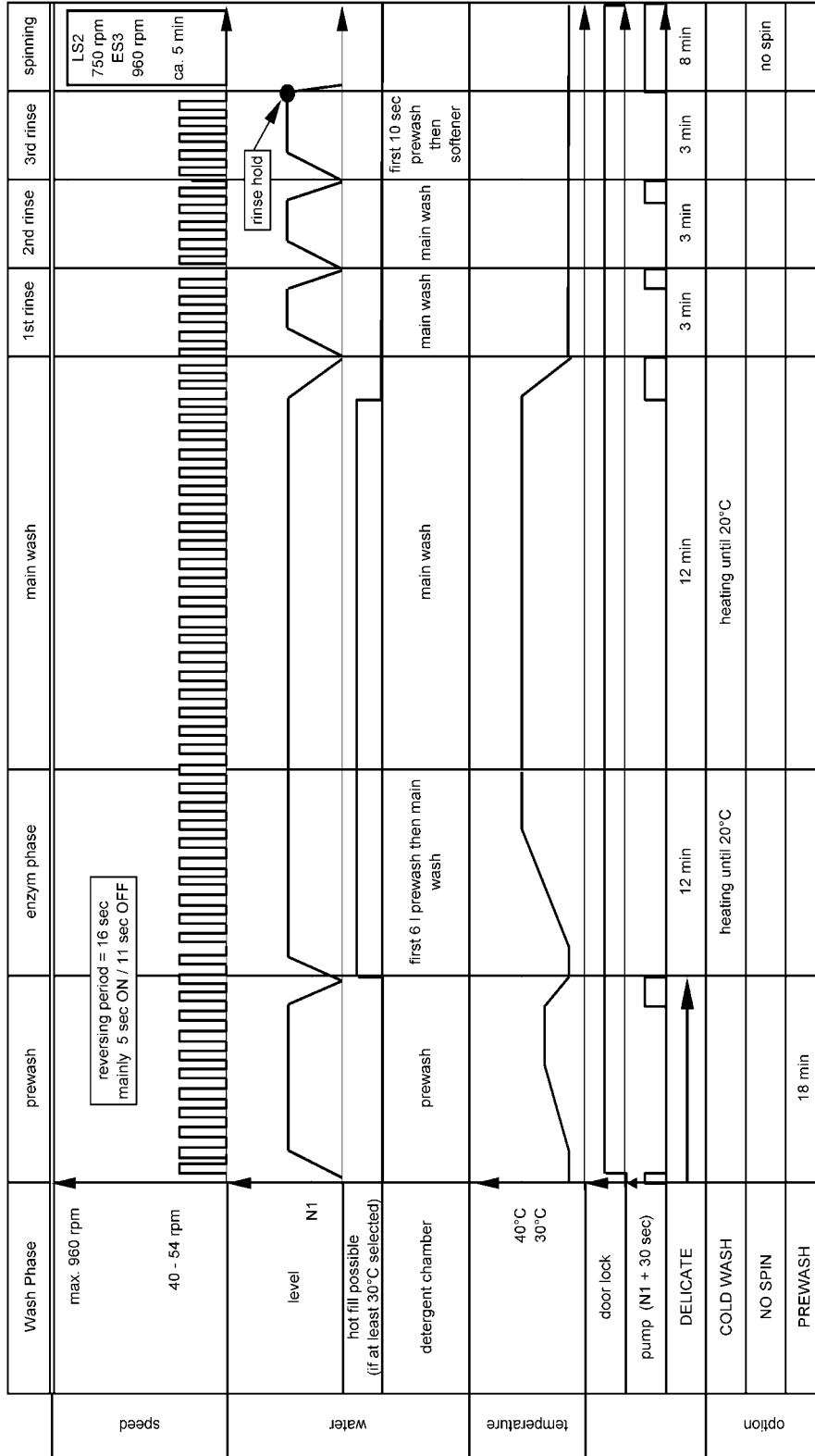

Program chart

4619 714 14471

Delta Domino Wash Cycle of Express / Quick wash

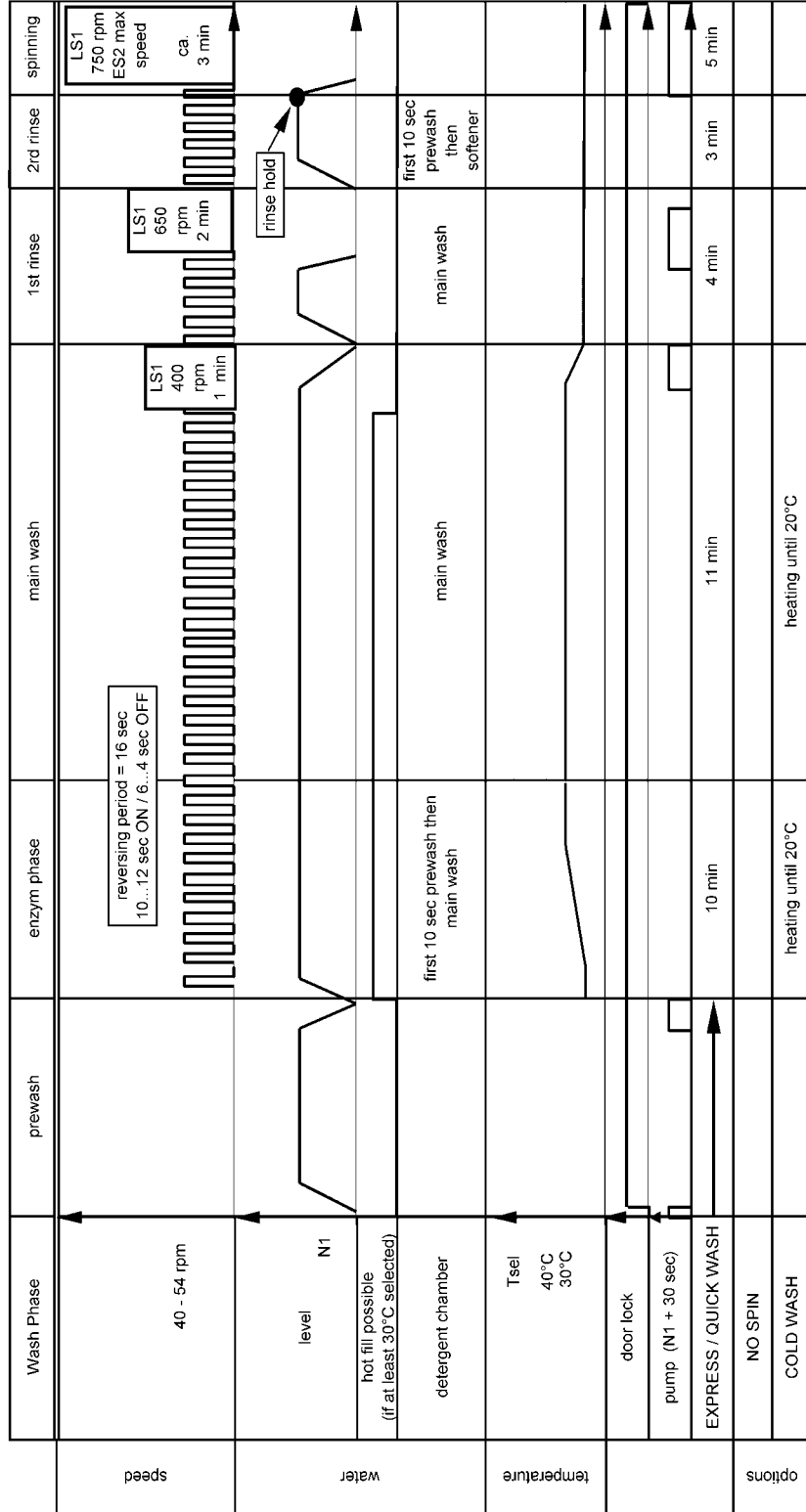

Program chart

4619 714 14471

Delta Domino Wash Cycle of Chrono / Daily load (1 h cycle)

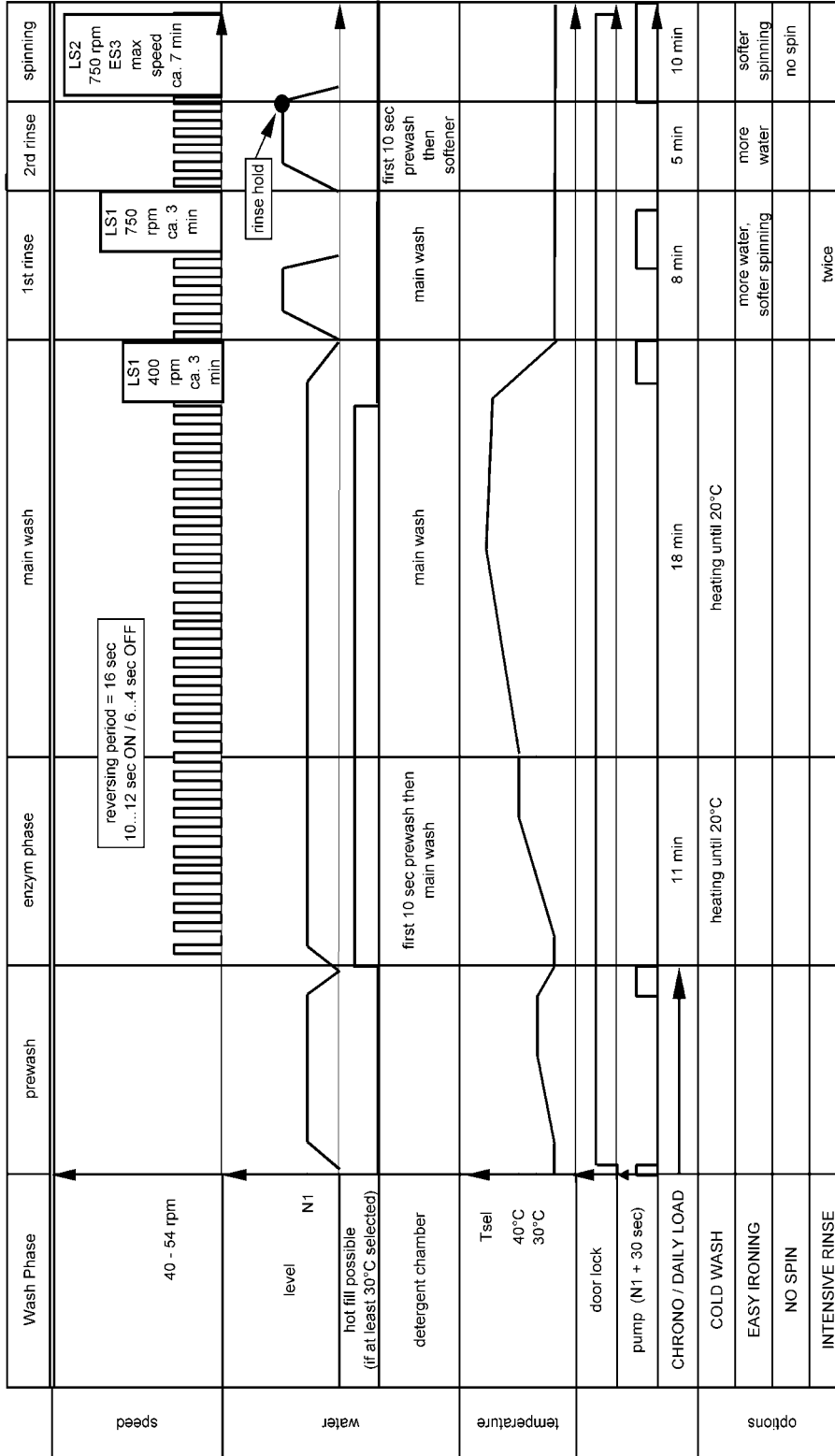

Program chart

Delta Domino Wash Cycles of Wool, Silk, Handwash, Lingerie 4619 714 14471

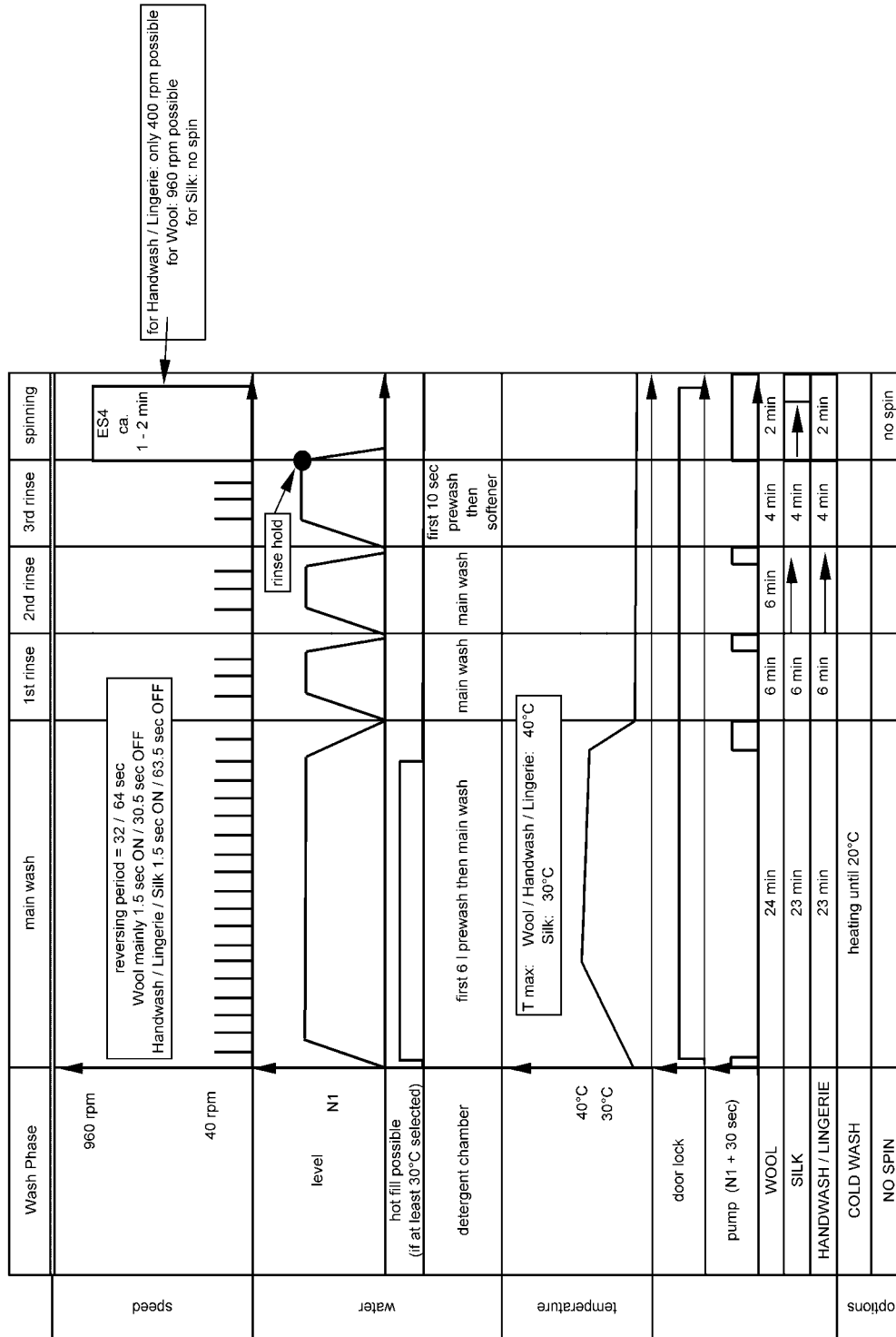

Program chart

4619 714 14471

Delta Domino Wash Cycle of Super Eco, Overnight only for 55 l and 60 l washer

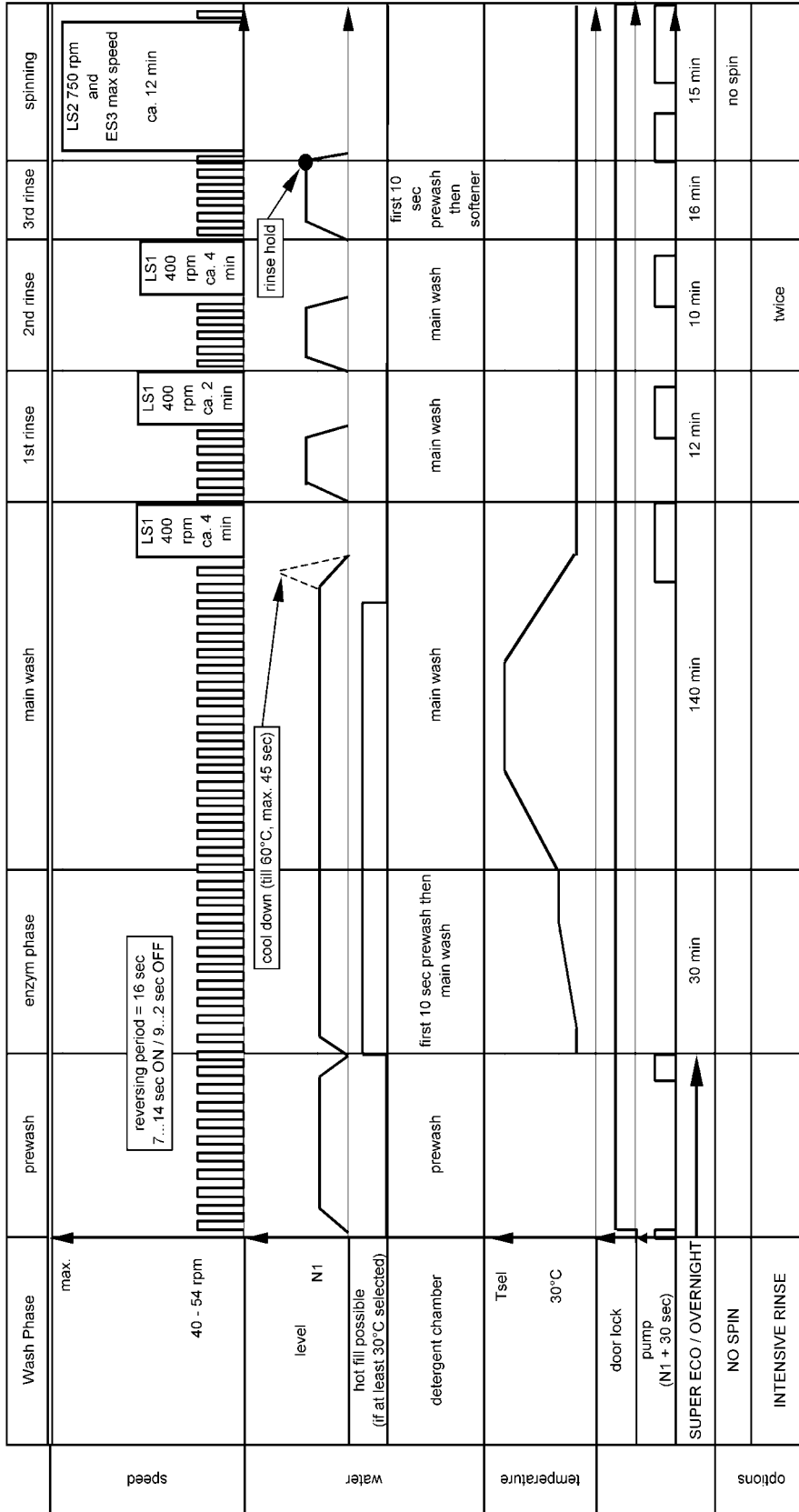

Program chart

4619 714 14471

Wash Cycle of Big Items only for 60 l washer

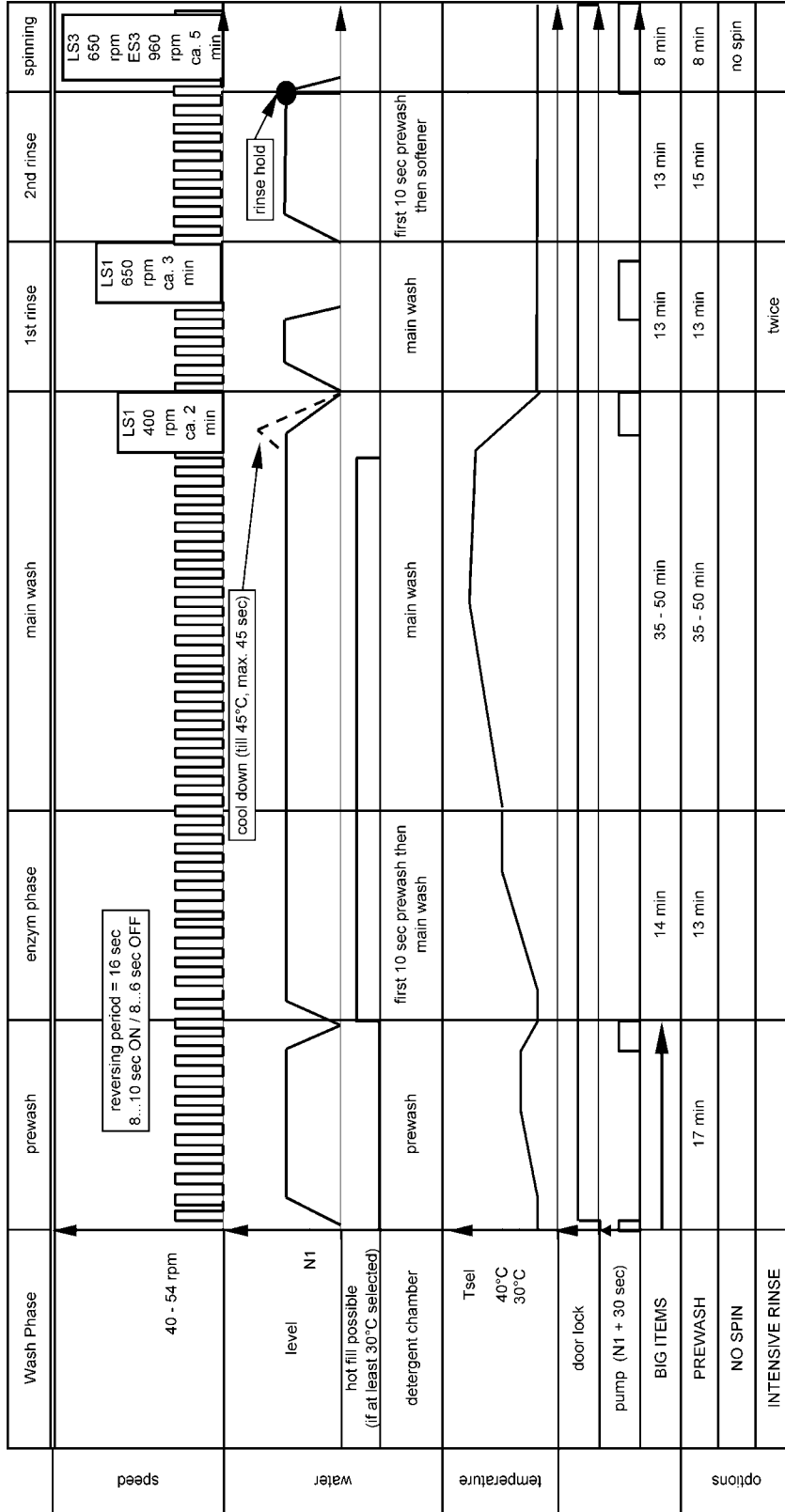

Program chart

4619 714 14471

Spinning Profiles

Delta Domino

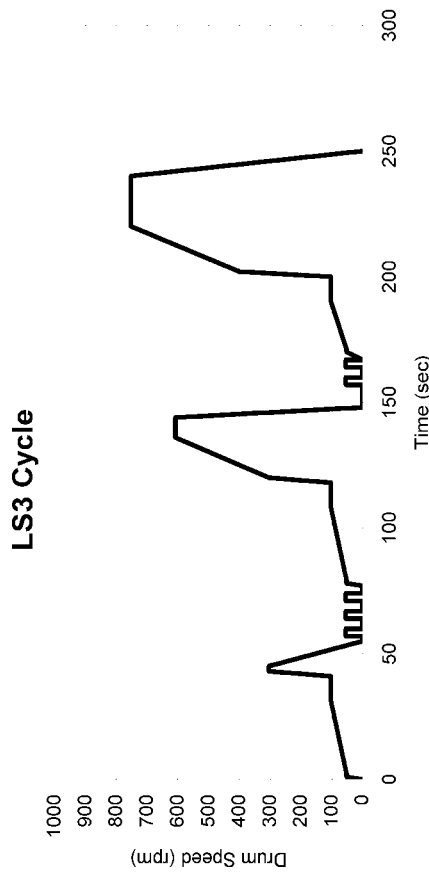
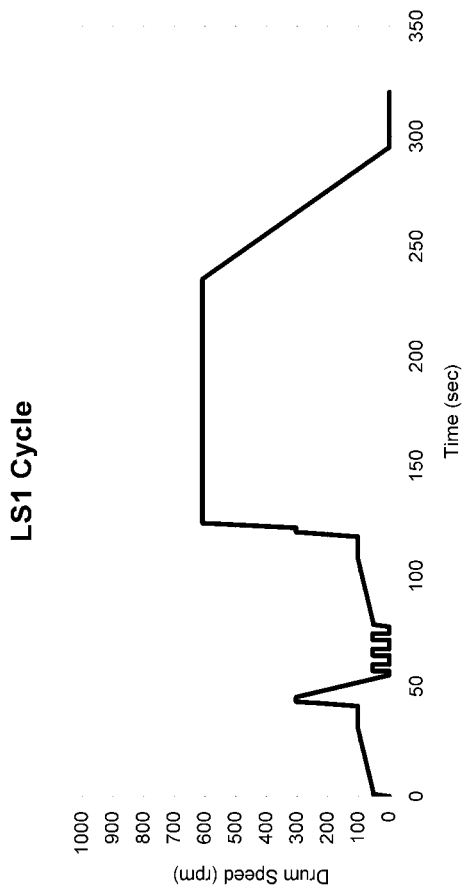
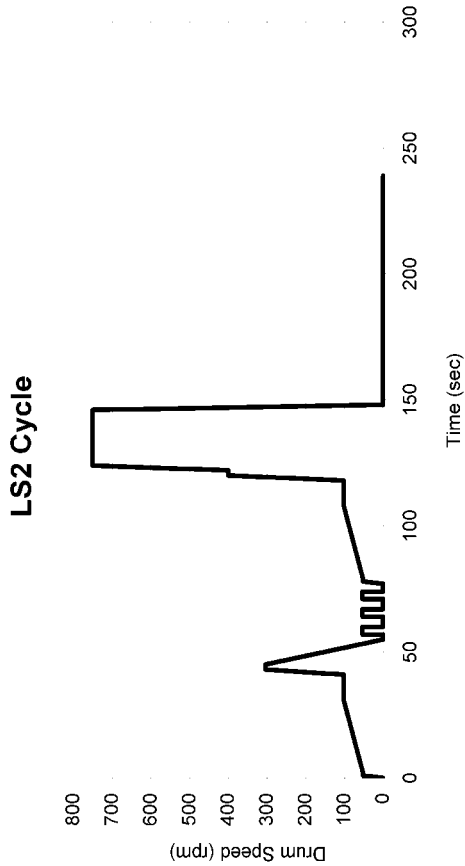

Program chart

4619 714 14471

Spinning Profiles

Delta Domino

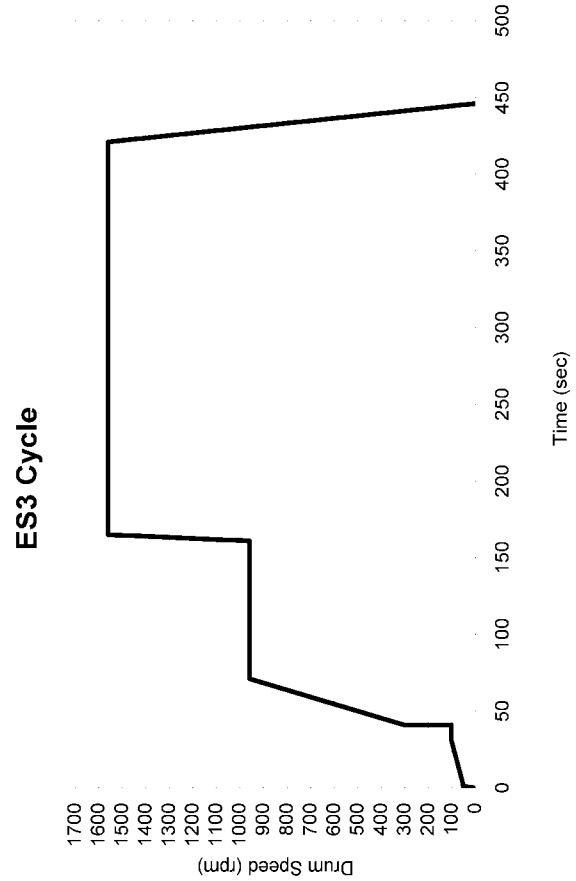
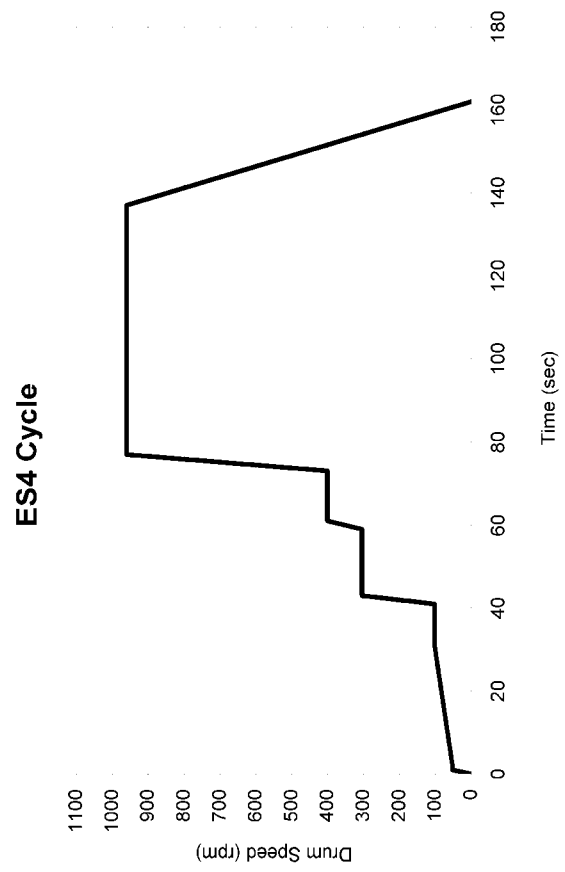
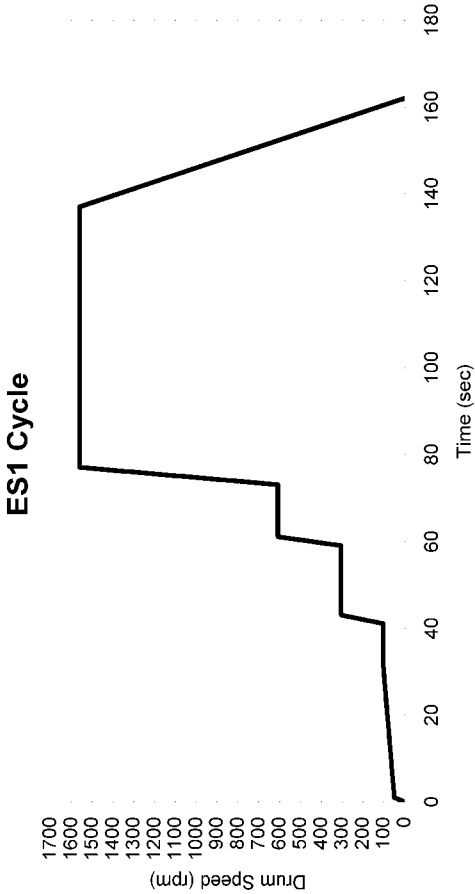
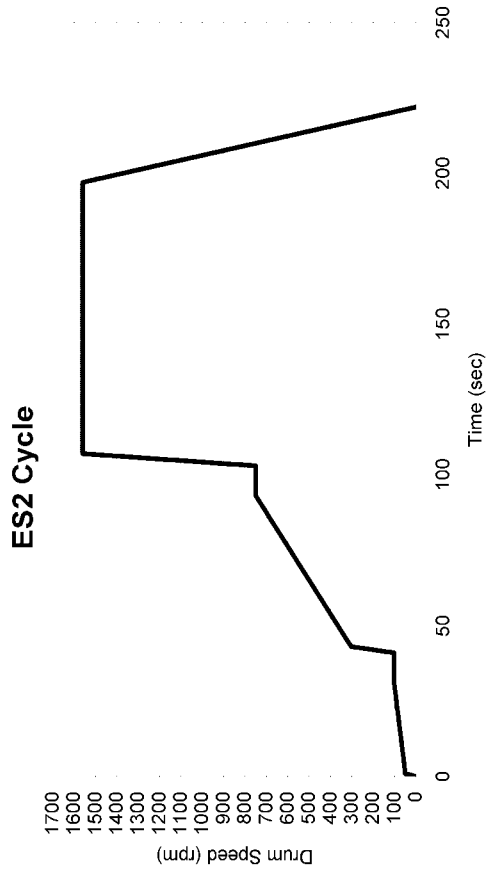

Text/Legend







DOMINO

Test Program

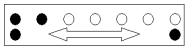
4619 714 04651

1. Switch ON the appliance
2. Close the Door
3. Selected the DRAIN program
4. Press Push button (PB) Reset 4 times within 5 seconds
5. Go to the next step press PB Reset twice

Attention: Use the test program only without laundry!

LED Status	Digits *	Description of the Program Flow	Check to perform
	-- 0	The door is locked. The CUC is performing the Selftest.	CUC detects <ul style="list-style-type: none"> F05, F08, F12, F13, F14, F15, F23
	-- 1	Fill 15" hot valve (only if hot fill appliance) Fill 15" in prewash (PW) Fill 15" in mainwash (MW) Fill 15" in PW + MW (Softener) Fill by MW to wash level. Motor is reversing.	Technician: <ul style="list-style-type: none"> Check the valve activation Check the dispensing into the dispenser Check the pressure switch
	-- 2	The heating element is switched ON. Motor is reversing.	Technician: <ul style="list-style-type: none"> Check heating element activation Check if the motor is reversing CUC detects: <ul style="list-style-type: none"> F06, F07, F27
	-- 3	The drain pump is switched ON until the wash level = OFF + 5" motor is reversing.	Technician: <ul style="list-style-type: none"> Check drain pump activation Check pressure switch operation Check if the motor is reversing CUC detects: <ul style="list-style-type: none"> F06, F07, F27
	-- 4	The motor is driven to maximum speed. Drain pump is ON.	Technician: <ul style="list-style-type: none"> Check if the motor is running at max. speed Check drain pump activation CUC detects: <ul style="list-style-type: none"> F28
	-- 5	Motor is switched OFF. Door is unlocked.	Technician: <ul style="list-style-type: none"> Check if the door is unlocked CUC detects: <ul style="list-style-type: none"> F13





- Digits 1,2, (the left on) are executing an animation

Text/Legend

DOMINO

Test Program

4619 714 04651







Failure Indication		Explanation and Recommended Procedure
On Status LEDs	On Digits if available	
	<p>Remaining Time</p>	<p>No water detected entering machine or pressure switch trip not detected.</p> <p>If after 6 minutes the control does not detect water entering machine and then valves will be turned off and the LED Water Tap will be switched ON.</p> <p>The Control is in Pause Mode. If it was possible to remove the failure, by pushing PB Start the appliance will restart.</p> <p>Potential Causes</p> <ul style="list-style-type: none"> • If there is no water in the unit: <ul style="list-style-type: none"> • Make sure that both valves at the water source(s) are turned on all the way. • Check for plugged or kinked inlet hoses or plugged screens in the inlet valves. • Verify inlet valve operation. • If there is water in the unit: <ul style="list-style-type: none"> • Pressure switch hose is in good condition and properly connected to tub and pressure switch. • Verify there is not a siphon problem. • Verify wire harness connections to; inlet valves, pressure switch and central control unit (CUC). • Check all hoses for possible leaks. • Verify pressure switch operation. • Verify CUC operation.
	<p>FA</p> <p>F02</p>	<p>Aquastop Failure</p> <p>If the aquastop contact on the bottom tray of the appliance is closed for more than 30" an aquastop failure will be detected. In aquastop condition, the door will remain locked and the drain pump will run constantly.</p> <p>Potential Causes</p> <ul style="list-style-type: none"> • If there is water in the bottom tray of the appliance: <ul style="list-style-type: none"> • Check all hoses for any leakage. • Check if there was an overfoam due to too much detergent used. • Check the tub for any leakage. • If there is no water in the bottom tray <ul style="list-style-type: none"> • Check if the aquastop switch has a short circuit. • Check if the aquastop wiring is properly connected. • Verify CUC operation.
	<p>Remaining Time</p> <p>During test program</p> <p>F03</p>	<p>Long Drain</p> <p>If the drain time exceeds 4 minutes, the LED clean Filter is turned ON.</p> <p>The control is in Pause Mode. If it was possible to remove the failure, by pushing PB Start the appliance will restart</p> <p>Potential Causes</p> <ul style="list-style-type: none"> • Check the drain hose and make sure it is not plugged or kinked • Check the electrical connections at the pump and make sure the pump is running. • Check the drain pump filter for foreign objects. • Check the electrical resistance of the drain pump.
	<p>F04</p>	<p>Too Long Heat Time</p> <p>If the water temperature is not increasing over 35°C during 40 minutes of the first heating step in the cycle the CUC will display this Error.</p> <p>Potential Causes</p> <ul style="list-style-type: none"> • Check the electrical resistance of the heating element. • Check Wire Harness connections to the heating element, NTC and CUC. • Check the electrical resistance of the NTC.
	<p>F05</p>	<p>Water Temperature Sensor Error</p> <p>If during the water heating step in the wash cycle, the water temperature sensor (NTC) value is out of range, the F05 error code will be displayed.</p> <p>Potential Causes</p> <ul style="list-style-type: none"> • Check the NTC resistance. • Check connections to the NTC and CUC.

Text/Legend

DOMINO

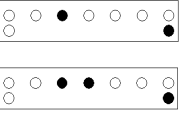
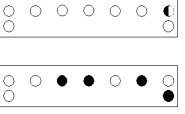
Test Program

4619 714 04651







	<p>F06</p>	<p>Drive Motor Tachometer Error</p> <p>The control is unable to properly detect motor speed (several times) and the machine will shut down. If a failure occurs during high speed spin the door will be unlocked after the drum has stopped rotating.</p> <p>Potential Causes</p> <ul style="list-style-type: none"> • Check wire harness connections between the motor and CUC. • Check the resistance of the tachometer circuit on the motor. • Check resistances of the motor windings.
	<p>F07</p>	<p>Motor Control Triac Error</p> <p>The main control has detected a short circuit in the motor control triac. If a failure occurs during high speed spin the door will be unlocked after the drum has stopped rotating.</p> <p>Potential Causes</p> <ul style="list-style-type: none"> • Check CUC by running Test Program.
	<p>F08 F12</p>	<p>Heater Circuit Error</p> <p>The main control has detected a heater circuit failure. This failure modes are checked before the cycle starts and after the spinning steps.</p> <p>Potential Causes</p> <ul style="list-style-type: none"> • Check the resistance of the heater connectors to the ground. • Check the resistance of the heater. • Check the wiring connectors to the heater and CUC. • Check the CUC.
<p>LED Door open flashing for 10"</p> 	<p>Only during test program F13</p>	<p>Door Open LED flashing after the cycle is started</p> <p>If the CUC is not able to lock the door of the washer after program start within 10", the door open LED will flash for 10".</p> <p>Potential Causes</p> <ul style="list-style-type: none"> • Check if the door is closed properly. • Check if there is a mechanical problem on the door lock system. • Check the wiring/harness between the CUC and the door lock. • Start the Test Program. If the problem persists the error Code F13 will be displayed.
	<p>F14</p>	<p>EEPROM Error</p> <p>The CUC receives it's data from an EEPROM on board the CUC. If there is an error reading this data it will cause this failure indication.</p> <p>Potential Causes</p> <ul style="list-style-type: none"> • A power glitch (mains disturbance) may cause this error: Run the Test Program. This will perform a complete check of the EEPROM. If the failure is detected during the Test Program replace the CUC.
	<p>F15</p>	<p>Drum Up Circuit Missing (only for TOPLOADERS with DRUM UP Circuit)</p> <p>If the CUC is not detecting the Drum Up switch closing during Motor rotation this failure is displayed. This Error is detected ONLY during the Test Program.</p> <p>Potential Causes</p> <ul style="list-style-type: none"> • Check the position of the electromagnetic device. • Check the position of the reed sensors. • Check the resistance of the reed sensor. • Check the wiring connection between the reed sensor and the CUC.
	<p>F21</p>	<p>User Interface Error (detected only with Smart user interfaces)</p> <p>If the communication between user interface module and CUC is disturbed, this Error is displayed. If the failure is displayed on the digits the display module is not able to "talk" to the CUC. If the failure is displayed on the status LED the CUC is not able to contact the Display module.</p> <p>Potential Causes</p> <ul style="list-style-type: none"> • Check wiring connection to the display module. • Check display module. • Check CUC.

Text/Legend

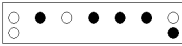
DOMINO

Test Program

4619 714 04651

	<p>F23</p>	<p>Pressure switch Failure</p> <p>If the CUC detects during the wash cycle that the pressure switch contact for the wash level and the pressure switch level for the heater safety are ON simultaneously for 10" this failure will be displayed.</p> <p>Potential Causes</p> <ul style="list-style-type: none"> • Check the resistance of the pressure switch contacts. • Check the wiring of the connection to the pressure switch and to the CUC. • Start the Test Program. If the problem persists F23 will be displayed.
	<p>F24</p>	<p>Overflow Failure</p> <p>If the overflow contact on the pressure switch is closed for more than 60" the overflow failure will be indicated. In this overflow condition, the Door will remain locked and the drain pump will run constantly.</p> <p>Potential Causes</p> <ul style="list-style-type: none"> • Check the drain hose and make sure it is not plugged or kinked. • Check Wire Harness connections to the drain pump, pressure switch, and CUC. • Check/clean drain pump filter of foreign objects. • Check for drain pump failure. • Check the inlet valve for proper shut off. • Check the pressure switch for proper operation.
	<p>F26</p>	<p>Pump Driver Failure</p> <p>If the CUC detects during the wash cycle that the triac of the pump is defective it will display this failure.</p> <p>Potential Causes</p> <ul style="list-style-type: none"> • Check the resistance of the pressure switch contacts. • A failure of the pressure switch could also cause the Code. • If OK. Start Service test to check the CUC. If the failure occurs replace the CUC.
	<p>Only during test program</p> <p>F27</p>	<p>Reversing relay failure</p> <p>If the CUC detects that the motor is possible to rotate only in one direction this failure is displayed.</p> <p>Potential Causes</p> <ul style="list-style-type: none"> • Check the harness to the motor. • Check the CUC.
	<p>Only during test program</p> <p>F28</p>	<p>Tapped Field Failure</p> <p>If the CUC is not able to switch ON the tapped field of the Motor, this failure Code is displayed.</p> <p>Potential Causes</p> <ul style="list-style-type: none"> • Check if the correct motor is build in. • Check the resistance of the fields of the motor. • Check the harness between Motor and CUC. • If the points above are OK replace the CUC.
	<p>Fod</p>	<p>Foam detected During the Wash Cycle</p> <p>If the CUC is not able to drain out the water after washing or not able to spin after several trials this alarm Code is displayed.</p> <p>Potential Causes</p> <ul style="list-style-type: none"> • Customer used too much detergent. • Check if there is any problem with the pump hoses. • Check the electrical resistance of the pump. • Check the electrical resistance of the pressure switch. • Check if pressure switch hose is in good condition and properly connected to tub and pressure switch. • Verify there is not a syphon problem.
	<p>bdd</p>	<p>Blocked Drum Detected (only for Top Loader Appliances)</p> <p>Timer detects problems with driving of the motor at the beginning of the cycle or after pause mode when door lock have been unlocked.</p> <p>Potential Causes</p> <ul style="list-style-type: none"> • Check if the Drum door are properly closed • Check the Belt position • Check the F06 Case