

701/702
Documenting
Process
Calibrator

*Quick
Reference
Guide*



FLUKE

701/702 Documenting Process Calibrator

*Quick
Reference
Guide*



PN 942784
July 1994
©1994 Fluke Corporation.
All rights reserved. Printed in U.S.A.
All product names are trademarks of
their respective companies.

FLUKE®

 **Safety Information** (See Users Manual for complete information.)

- Before you use the calibrator, inspect the insulating cover. Look for cracks or missing plastic. Pay particular attention to the insulation surrounding the connectors. Do not use the calibrator if it is damaged.
- Disconnect the power and discharge all high-voltage capacitors in the equipment under test before testing resistance or continuity.
- Inspect the test leads for damaged insulation or exposed metal. Check test lead continuity. Replace damaged test leads.
- Do not use the calibrator if it looks damaged or if it operates abnormally. Protection may be impaired. When in doubt, have the calibrator serviced.
- Select the proper function and range for your measurement.
- Use caution when working above 42V dc or 25V ac rms. Such voltages pose a shock hazard.
- When using the probes, keep your fingers away from the probe contacts. Keep your fingers behind the finger guards on the probes.
- Connect the common test lead before you connect the live test lead. When you disconnect test leads, disconnect the live test lead first.
- Do not operate the calibrator around explosive gas, vapor, or dust.
- When using a pressure module, make sure the process pressure line is shut off and depressurized before you connect it to the pressure module.
- Disconnect test leads before changing to another measure or source function.
- Designed and tested in accordance with IEC-1010-1. Use the calibrator only as specified in this Guide or the Users Manual; otherwise the protection provided by the calibrator may be impaired.
- When servicing use only specified replacement parts.

International Electrical Symbols

-  Calibrator is protected throughout by double insulation or reinforced insulation.
-  Caution! Refer to this manual before using the Calibrator.
- CAT II** Overvoltage (Installation) Category II per IEC 1010-1 refers to the level of Impulse Withstand Voltage protection provided. Typical locations include; Mains Wall outlets, local appliances and PORTABLE EQUIPMENT.

Contents	Page
Introduction	1
Function Summary	1
Charging the Battery and Battery Life	2
Input and Output Jacks	3
Keys	4
Using Measure Mode	6
Measuring Electrical Parameters	6
Measuring Pressure	7
Measuring Temperature	8
Measurements in Percent of Scale	10
Dampening Your Measurements	10
Using Source Mode	11
Sourcing Electrical Parameters	11
Generating a Frequency	12
Simulating Thermocouples	12
Simulating RTDs	13
Stepping the Output	13
Sourcing Pressure	14
Simultaneous Measure/Source Mode	16
Calibrating a Process Instrument	18
Generating As Found Test Data	18
Adjusting the Transmitter	21
Generating As Left Test Data	21
Memory Operations	22
Saving the Measure, Source, or Measure/Source Results	22
Review Memory	23
Clearing Memory	24
Loop Power	25
Using Setup Mode	26
Using the Battery Save Feature	27
Using the Backlight Timeout Feature	27
Selecting the Display Language	28
Selecting Date Format	28

Using Your 701/702 Quick Reference Guide

This Quick Reference Guide to the Model 701 and 702 Documenting Process Calibrators describes how to do the following:

- Make measurements using MEASURE mode.
- Simulate input signals using SOURCE mode.
- Calibrate an instrument using simultaneous MEASURE/SOURCE mode.
- Store data.
- Use the internal current loop supply.
- Change various **SETUP** parameters.

The 701 and 702 have many more features. Refer to the *Users Manual* for the ramp, trip detect, and data logging functions. Refer to the *PMLink™* manual for how to interface the 702 with a PC.

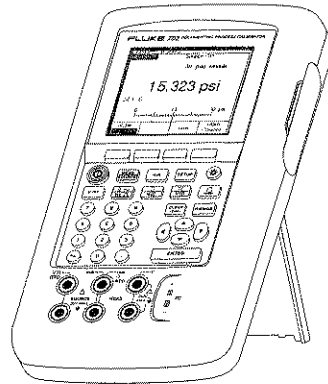

Introduction

The step by step procedures in this guide use the following conventions:

Softkey labels are shown in boldface type. For example, **Scale %** means press the **Scale %** softkey.

Keypcap pictures mean press the keys shown in the sequence shown.

For example, **mA** ② ① **ENTER** means press the **mA** key followed by ②, and so on. **TC RTD** **TC RTD** means press the **TC RTD** key twice.

Function Summary

FUNCTION	MEASURE	SOURCE
V_{DC} dc V:	0 to +/-300V	0 to 11V in V or mV units, 10 mA max
V_{AC} ac V:	0 to 300V, 5 kHz max	No sourcing
V_{FREQ} Frequency:	1 Hz to 50 kHz, 100 mV to 300V rms	1 mV to 10V pk square wave, 2 Hz to 50 kHz, to simulate pulsed flow-rate sensors and tachometers
mA dc Current:	0 to 110 mA	0 to 22 mA, 28V max
Ω Resistance:	0 to 11 kΩ	0Ω to 11 kΩ
Ω Continuity:	Low resistance generates a beep	No sourcing
TC RTD RTD:	100Ω Platinum, -200 to +800°C 120Ω Nickel, -80 to 260°C 2-, 3-, or 4-wire	100Ω Platinum, -200 to +800°C 120Ω Nickel, -80 to 260°C 2 wire
TC RTD Thermocouple:	E, N, J, K, T, B, R, S, or C	
Ω Pressure:	8 modules ranging from a low of 0 to 10" H ₂ O (0-2.5 kPa) through a high of 0 to 1000 psi (0-7000 kPa).	Measure external pressure source.*
SETUP Loop Power:	24 or 28V, 22 mA max	
* Use an external hand pump or other pressure source as a pressure stimulus for the source pressure function.		

Charging the Battery and Battery Life

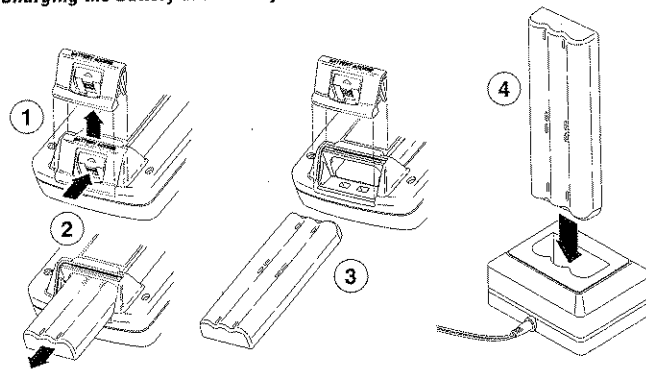

When the annunciator appears, stop using the calibrator and charge the battery. For longest battery life, wait for the annunciator to appear before you charge the battery. When battery save is enabled, the indicator shows in reverse video. See the battery save feature on page 27.

Typical Battery Life

OPERATING MODES	BACKLIGHT OFF	BACKLIGHT ON
Measure, continuous	6.5 Hours	6 Hours
Measure and source, with loop power on, continuous	3.5 Hours	3 Hours
Typical intermittent operation	> 8 Hours	> 8 Hours

Use only Fluke Model BP7217 replacement battery pack.

Do not dispose of Nickel-Cadmium batteries with other solid waste. Contact Fluke Corporation for recycling information. See SERVICE at the back of this guide.

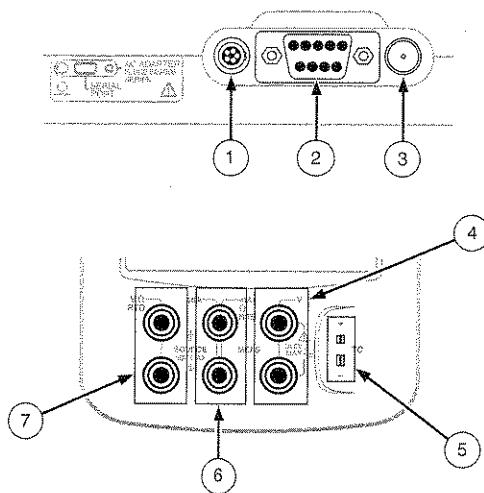

Input and Output Jacks

- 1 Input connector for a pressure module.
- 2 (Model 702) PC SERIAL PORT.
- 3 Battery Eliminator input jack.
- 4 For measuring voltage, frequency, or three- or four-wire RTDs (Resistance Temperature Detectors).
- 5 For measuring or simulating thermocouples.
- 6 For sourcing or measuring current, measuring resistance and RTDs, and supplying loop power.
- 7 For sourcing voltage, resistance, or square waves and for simulating RTDs.

Keys

- 1 Turns the power on and off.
- 2 Cycles the calibrator through MEASURE, SOURCE, and MEASURE/SOURCE modes.
- 3 Selects mA (current) measure or source function. For loop power on/off, go to the **SETUP** mode.
- 4 Enter and exit the **SETUP** mode to modify operating parameters.
- 5 Perform the function defined by the label above each key on the display.
- 6 Turns the backlight on and off.
- 7 Selects the pressure measurement function.
- 8 Selects TC (thermocouple) or RTD (resistance temperature detector) measurement or sourcing functions.

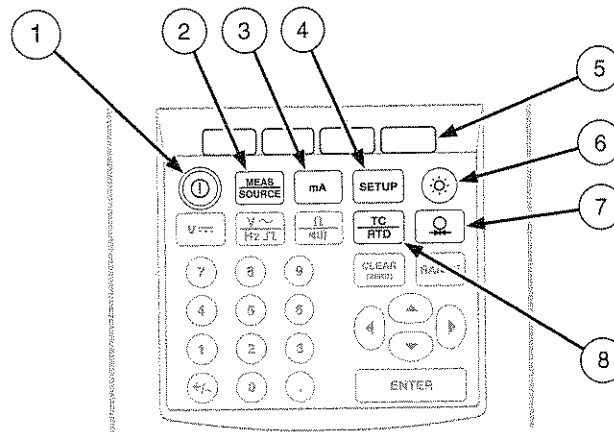

- 9 Toggles between autorange and locked range in MEASURE mode, and increments range. Each time you press **[RANGE]**, the calibrator locks on the next higher range. Press this key again for 2 seconds to resume autorange.
- 10 Clears a partial data entry or zeros the output when in the SOURCE mode.
- 11 Use to adjust the display contrast. Also, use to make selections when prompted. These keys also increment or decrement the sourced output in steps.
- 12 Terminates a numeric entry when setting a source value, or selects entries from lists.
- 13 Toggles between resistance and continuity functions in MEASURE mode, or selects the resistance function in SOURCE mode.
- 14 Use whenever a numeric entry is required.
- 15 Toggles between ac voltage and frequency functions in the MEASURE mode, or selects frequency output in the SOURCE mode.
- 16 Selects the dc voltage function in the MEASURE mode, or selects dc voltage in the SOURCE mode.

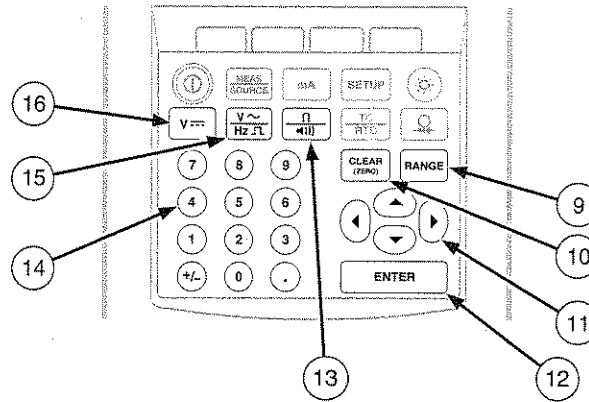

Using Measure Mode

Press **MEAS** until the calibrator is in MEASURE mode. The word MEASURE shows in the mode indicator bar at the top of the display. You must be in MEASURE mode to change measurement parameters.

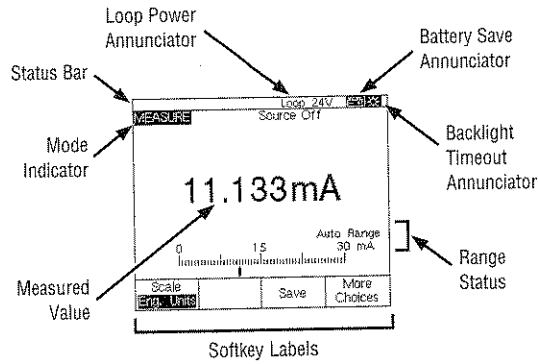

Measuring Electrical Parameters

1. Press **MEAS** for MEASURE mode.
2. Press **mA**, **V $\overline{\sim}$** , **V \sim Hz Π** , or **Ω** .
3. Connect the test leads as shown.

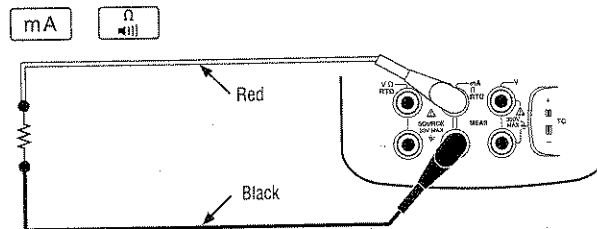
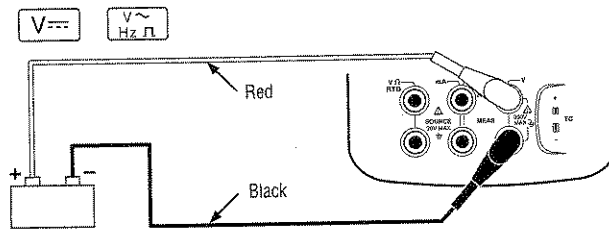

Measuring Pressure

WARNING

TO AVOID A VIOLENT RELEASE OF PRESSURE IN A PRESSURIZED SYSTEM, CLOSE THE ISOLATION VALVE AND SLOWLY BLEED OFF THE PRESSURE BEFORE YOU CONNECT OR DISCONNECT THE PRESSURE MODULE.

1. Attach the appropriate pressure module for the pressure to be tested. Pressure modules are available in gage or differential types depending on range.

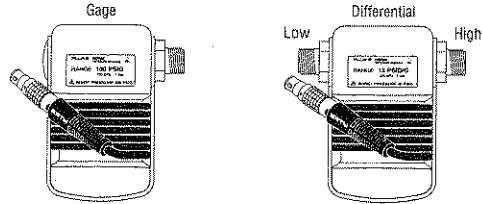

2.  for MEASURE mode.

3. .

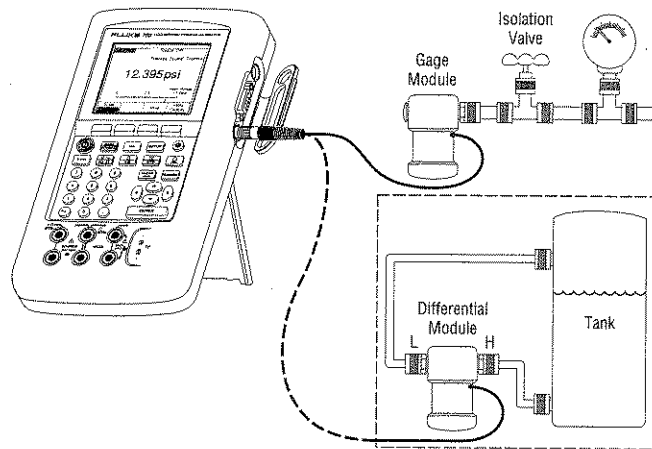

Measuring Temperature

USING THERMOCOUPLES

Thermocouple Types Accepted for Input

Type	Positive Lead (H) Color			Negative Lead Material	Specified Range (°C)
	Material	ANSI*	IEC**		
E	Chromel	Purple	Violet	Constantan	-250 to 1000
N	Nicrosil	Orange		Nisil	-200 to 1300
J	Iron	White	Black	Constantan	-210 to 1200
K	Chromel	Yellow	Green	Alumel	-200 to 1372
T	Copper	Blue	Brown	Constantan	-250 to 400
B	Platinum (30% Rhodium)	Gray		Platinum (6% Rhodium)	600 to 1820
R	Platinum (13% Rhodium)	Black	Orange	Platinum	0 to 1767
S	Platinum (10% Rhodium)	Black	Orange	Platinum	0 to 1767
C***	Tungsten (5% Rhenium)	White		Tungsten (26% Rhenium)	0 to 2316

* American National Standards Institute (ANSI) device negative lead (L) is always red.
 ** International Electrotechnical Commission (IEC) device negative lead (L) is always white.
 *** Not an ANSI designation but a Hoskins Engineering Company designation.

1. Select °C or °F in **SETUP** mode.
2. Attach the thermocouple to the TC jack using the appropriate minijack adapter. (Fluke Model 80CJ-M for J-type and 80CK-K for K-type thermocouple.)
3. **MEAS SOURCE** for MEASURE mode.
4. **TC ATD**.
5. **ENTER** to select thermocouple type.

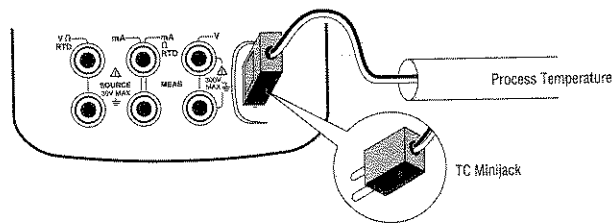

USING RESISTANCE-TEMPERATURE DETECTORS (RTDs)

The following table shows the RTD types accepted.

RTD Types Accepted

RTD Type	ICE Point (R_0)	Material	α	Range ($^{\circ}\text{C}$)
Pt100 (392)	100 Ω	Platinum	0.00392 $\Omega/^{\circ}\text{C}$	-200 to 630
Pt100 (385)	100 Ω	Platinum	0.00385 $\Omega/^{\circ}\text{C}$	-200 to 800
Ni120	120 Ω	Nickel	0.00672 $\Omega/^{\circ}\text{C}$	-80 to 260

1. **MEAS** for MEASURE mode.
2. **TC** / **RTD** for RTD menu.
3. **▲** / **▼**, **ENTER** to select RTD type.
4. Select 2, 3, or 4-wire.
5. Make connections as shown on the display or in the figure below.
6. **ENTER**.

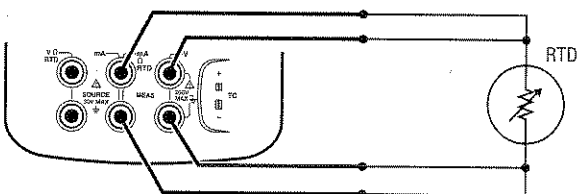
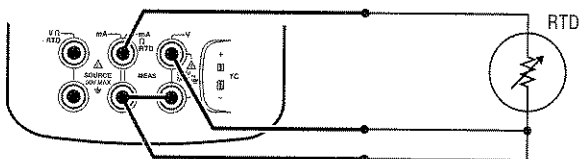
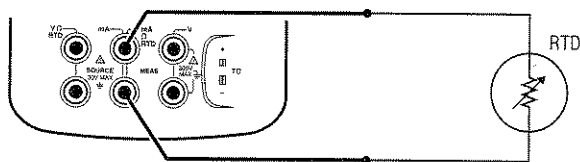

Measurements in Percent of Scale

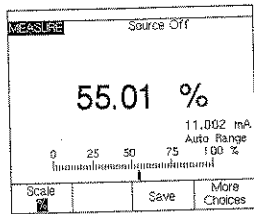

1. Press **MEAS SOURCE** for MEASURE mode.
2. Select measurement (example **mA**).
3. **Scale Eng. Units.**
4. Enter the endpoints (example 0% = 4 mA, 100% = 20 mA).
5. **Done.**
6. **Scale %** to return to display in engineering units.

Dampening Your Measurements

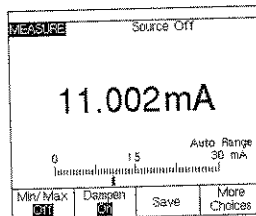

The software filter dampens measurements. This is the default operating state. Dampening is a running average of the last several measurements. To turn off dampening, proceed as follows:

1. Press the **Dampen On** softkey. The softkey label changes to **Dampen Off** and dampening is disabled.
2. Press **Dampen Off** to turn dampening on again.

Using Source Mode

Press **MEAS SOURCE** until the calibrator is in SOURCE mode. The word SOURCE shows in the mode indicator bar at the top of the display. You must be in SOURCE mode to change source or simulate parameters.

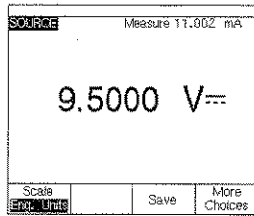

Sourcing Electrical Parameters

1. Connect the calibrator to the load as shown.
2. Press **MEAS SOURCE** for SOURCE mode.
3. Press **mA**, **V~**, **V~ Hz, Ω**, or **Ω**. (For **mA** select source mA or simulate transmitter, i.e. regulate current.)
4. Numerical value. Example, **5.00**.
5. Press **ENTER**.

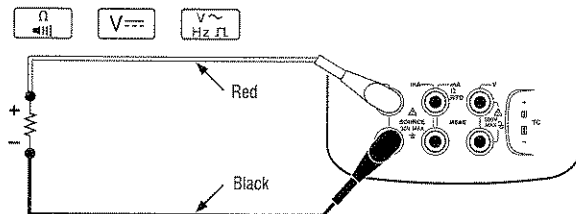
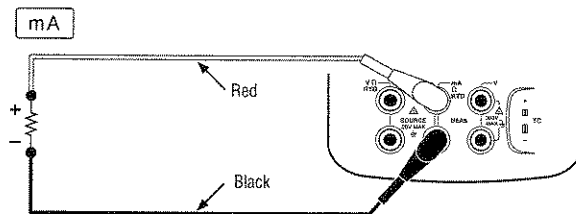

Generating a Frequency

1. Connect the calibrator as shown on previous page.
2. **MEAS** **SOURCE** for SOURCE mode.
3. **V_{rms}** **Hz** .
4. Enter the signal amplitude and frequency. The calibrator will supply a square wave.

Simulating Thermocouples

1. Connect the calibrator to the instrument under test with thermocouple wire and the appropriate thermocouple minijack as shown.
2. **MEAS** **SOURCE** for SOURCE mode.
3. **TC** **RTD** .
4. **▲** **▼** to select the desired thermocouple type.
5. **ENTER** .
6. Enter the desired temperature.
7. **ENTER** .

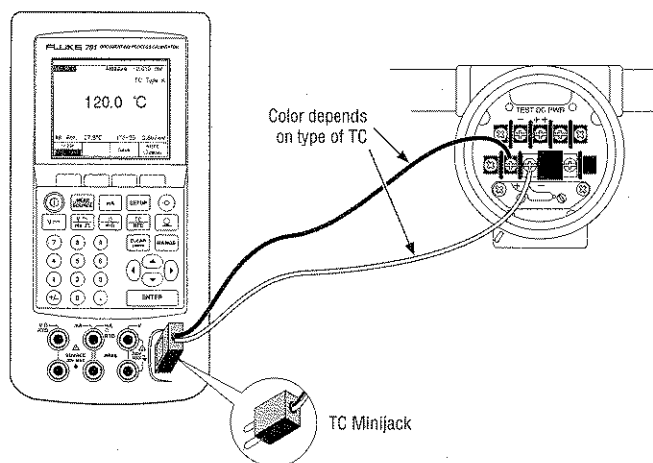

NOTE

If you use copper wire instead of thermocouple wire, the reference junction is at the input terminals of the instrument under test NOT inside the calibrator. Measure the external reference temperature and enter it as follows: Press **SETUP**, Set Ref. Junc. Compensat. to External. Enter the external reference value.

Simulating RTDs

1. Connect the calibrator to the instrument under test as shown.
2. Press **MEAS SOURCE** for SOURCE mode.
3. Press **TC RTD** twice.
4. Press **▲** or **▼** to select the desired RTD type.
5. Press **ENTER**.
6. Enter the desired temperature.
7. Press **ENTER**.

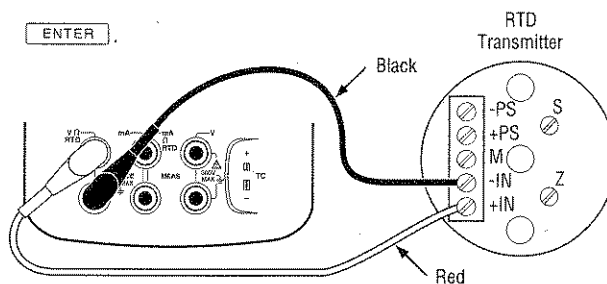
**Stepping the Output**

With the step feature, you can increment or decrement the output by pressing the **▲** or **▼** arrow keys.

You can use the step feature for sourcing electrical parameters and temperatures, but not pressure.

Using Source Mode

Steps are in engineering units (mA, volts, °C, etc.) or % of scale, depending on the setting of the **Scale/Eng Units** softkey prior to setting the step size. Stepping in % of scale is useful for quickly jumping between 0 and 100% (set step size = 100%) or 0-50-100% (set step size = 50%).

1. **MEAS SOURCE** for SOURCE mode.
2. Source function and value.
3. Press **More Choices** twice to get **Step Size** softkey.
4. **Step Size**.
5. Enter the step size as prompted on the display.
6. **Done**.
7.  to step the output.

Sourcing Pressure

The calibrator provides a source pressure function that requires the use of an external pressure hand pump or other pressure source.

WARNING

TO AVOID A VIOLENT RELEASE OF PRESSURE IN A PRESSURIZED SYSTEM, CLOSE THE ISOLATION VALVE AND SLOWLY BLEED OFF THE PRESSURE BEFORE YOU CONNECT OR DISCONNECT THE PRESSURE MODULE.

1. Attach the appropriate pressure module for the pressure to be tested. Pressure modules are available in gage or differential types depending on range.

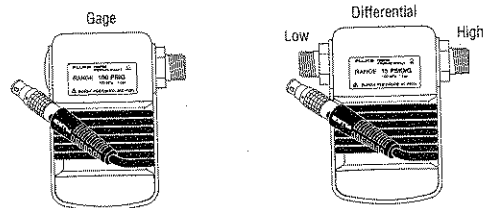

Using Source Mode

2. **MEAS SOURCE** for SOURCE mode.
3. .
4. Pressurize the pressure line with the external pressure source.
5. To change pressure readout to units in psi, bar, kPa, inHg, mmHg, in.H₂O, ft.H₂O press **BETUP** and select desired units.

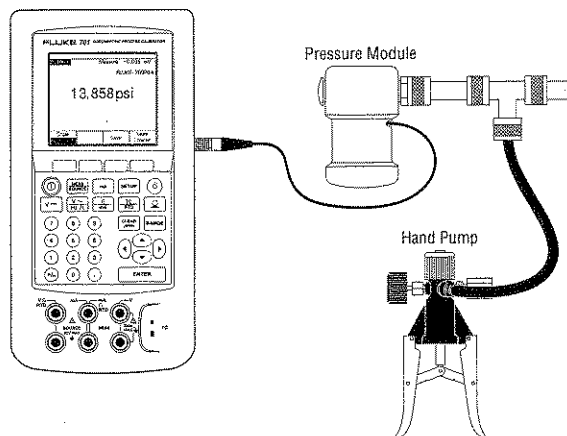

Simultaneous Measure/Source Mode

Use MEASURE/SOURCE mode to calibrate process instruments. Press **MEAS/SOURCE** so that the split screen display appears (see below).

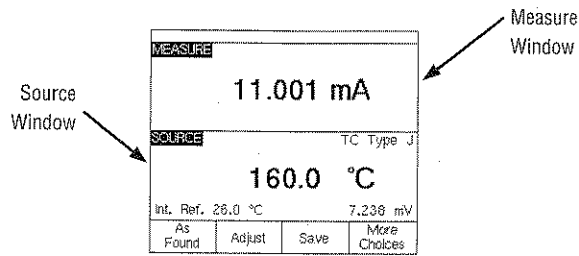

Allowed Simultaneous MEASURE/SOURCE Functions, Loop Power Off

MEASURE FUNCTION	SOURCE FUNCTION						
	dc V	mA	Freq	Ω	TC	2W RTD	Pressure
dc Volts	•	•	•	•	•	•	•
mA	•		•	•	•	•	•
ac Volts	•	•	•	•	•	•	•
Frequency (≥ 20 Hz)	•	•	•	•	•	•	•
Low Frequency (< 20 Hz)							
Ω	•		•	•	•	•	•
Continuity	•		•	•	•	•	•
TC	•	•	•	•		•	•
2W RTD	•		•	•	•	•	•
3W RTD	•		•	•	•	•	•
4W RTD	•		•	•	•	•	•
Pressure	•	•	•	•	•	•	

Allowed Simultaneous MEASURE/SOURCE Functions While
Sourcing Loop Power

MEASURE FUNCTION	SOURCE FUNCTION						
	dc V	mA	Freq	Ω	TC	2W RTD	Pressure
dc Volts	•		•	•	•	•	•
mA	•		•	•	•	•	•
ac Volts	•		•	•	•	•	•
Frequency (≥ 20 Hz)	•		•	•	•	•	•
TC	•		•	•		•	•
Pressure	•		•	•	•	•	

Calibrating a Process Instrument

The built-in calibration procedure is capable of testing most kinds of transmitters. After selecting the appropriate SOURCE and MEASURE functions, you can take an **As Found** data set, **Adjust** the transmitter to bring it into calibration, then take an **As Left** data set. You can store the results in memory for later recall.

Generating As Found Test Data

Example: Calibrating a Thermocouple Temperature Transmitter

1. Connect the calibrator to the instrument under test with thermocouple wire and the appropriate thermocouple minijack as shown.

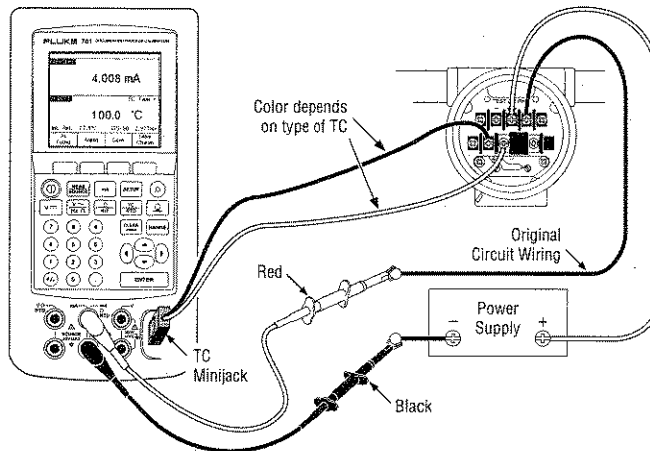

1. for MEASURE mode.
2. .
3. for SOURCE mode.
4. .
5. Select thermocouple type. .
6. Key in the desired test temperature. Suggestion: Key in a temperature corresponding to the bottom of the transmitter's range. .

7. MEAS SOURCE for MEASURE/SOURCE mode. The display changes as shown below:

MEASURE			
4.001 mA			
SOURCE		TC Type J	
100.0 °C			
Int. Ref. 26.3 °C		3.928 mV	
As Found	Adjust	Save	More Choices

8. **As Found** softkey. The display changes as shown below:

MEASURE			
0% Value	????? mA		
100% Value	????? mA		
Tolerance	????? %		
User-Entered Value	Disabled		
SOURCE		TC Type K	
0% Value		????? °C	
100% Value		????? °C	
Test Strategy		?????	
Abort			Done

9. The display prompts you to enter values for **0%**, **100%** and **Tolerance**.
10. **User Entered Value** is for a value measured by some other device, such as the reading reported by the control room. Leave this set to **Disabled** because you are only interested in values measured at the transmitter output.
11. Press the ⏴ key to move the cursor down to enter **0%** and **100%** values for SOURCE temperature. Our example uses 100.0 and 300.0°C.
12. The **Test Strategy** is the number of test steps and whether the test steps are performed rising and falling in percent of scale, or just rising or just falling. Our example uses five steps (0%, 25%, 50%, 75%, and 100%), rising only. Rising is indicated by the up arrow on the display. To change the test strategy, press ENTER, then use the ⏴⏵ keys to select the test strategy.

Calibrating a Process Instrument

- Press the **Done** softkey to complete the setup parameters. The display changes as follows.

MEASURE			
11.289 mA			
SOURCE		TC Type K	
160.0 °C			
Int. Ref.	29.5°C	ITS-90	5.354mV
Abort	Auto Test	Manual Test	

- For an automatic test, press **Auto Test**. To manually step through the test steps, press **Manual Test**.
- When finished, a results summary table such as the following is displayed. Failures are highlighted. An adjustment is required in this example because three tests show failures. The failures were outside the $\pm 0.5\%$ tolerance that we selected.

SOURCE	MEASURE	ERROR %
100.0 °C	3.806 mA	20.520
150.0 °C	7.964 mA	-0.224
200.0 °C	12.054 mA	0.336
250.0 °C	16.094 mA	0.536
300.0 °C	20.173 mA	16.030

Abort	Prev. Page	Next Page	Done
-------	------------	-----------	------

- Press **Done** to record the As Found data.

Adjusting the Transmitter

1. Press the **Adjust** softkey. The calibrator sources **0%** of span (simulated 100 °C thermocouple output in this example).
2. Adjust the transmitter *Zero* for 4 mA loop current then press the **Go to 100%** softkey.
3. Adjust the transmitter *Span* for 20 mA.
4. If the span was adjusted in step 3, you must go back and repeat steps 1, 2, and 3 until no more adjustment is required.
5. Now check the transmitter at 50%. If it is within specification, proceed to step 6. If not, adjust the linearity and begin this procedure again at step 1.
6. Press the **As Left** softkey to record *as left* data.

Generating As Left Test Data

1. Press the **Auto Test** softkey to begin an automatic sequence through all the test steps, or you can step through the tests manually.
2. When the tests are complete, observe the error summary table, such as the following.

SOURCE	MEASURE	ERROR %
100.0°C	3.985mA	-0.092
150.0°C	7.982mA	-0.070
200.0°C	12.027mA	0.170
250.0°C	16.023mA	0.144
300.0°C	19.983mA	-0.104

Abort	Prev. Page	Next Page	Done
-------	------------	-----------	------

3. If all the results are within specification, press the **Done** softkey. An alphanumeric entry window is presented for additional optional data as shown on the next page.

Memory Operations

Saving the Measure, Source, or Measure/Source Results

Press the **Save** softkey to save the data on the display for later review.



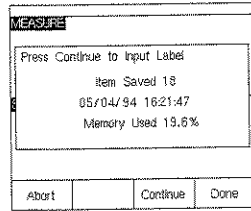

After you press **Save**, the calibrator saves the information on the display, a saved result index number, the data and time, and shows the following display:

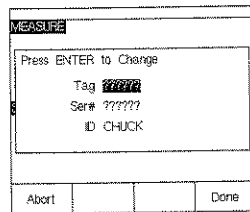

If you press the **Continue** softkey, the display prompts you to enter operator name (**ID**), instrument identifier (**TAG**), instrument serial number (**S/N**) as shown in the display below:



Memory Operations



Enter the alphabetic characters by highlighting them with the     keys followed by . Enter numbers with the keypad.

MEASURE			
Select character and press ENTER			
<input type="checkbox"/>	B	C	D
<input type="checkbox"/>	E	F	G
<input type="checkbox"/>	H	I	J
<input type="checkbox"/>	K	L	M
<input type="checkbox"/>	N	O	P
<input type="checkbox"/>	Q	R	S
<input type="checkbox"/>	T	U	V
<input type="checkbox"/>	W	X	Y
<input type="checkbox"/>	Z	,	.
<input type="checkbox"/>	-	*	/
Abort	Space	Back Space	Done

Review Memory

1. **More Choices** until **Review Memory** appears.
2. **Review Memory**.

Results From 04/25/94		1 of 54	
Measure Only	12:27:05		
Tag ID	12:28:07		
Min/Max	12:28:17		
Source Only	12:28:23		
Source Only	12:28:31		
Measure Source	12:28:52		
Source Only	12:29:14		
Source Only	12:29:24		
Measure Source	12:29:31		
Measure Only	12:31:28		
Go To Result	Prev. Page	Next Page	Done

3. Scroll through saved results with **Next Page**, **Prev Page**, or **Go To Result**.
4.   to select the desired saved result.
5. . The saved result appears on the display.
6. **Done** to select another result.
7. **Done** to return to normal operation.

Clearing Memory

1. **More Choices** until **Clear Memory** appears.
2. **Clear Memory**.
3. Displayed message indicates Clear Memory to clear results memory. Abort to retain results memory and return to normal operation.

Loop Power

With the loop power function, you can test a transmitter before you install it or when it is disconnected from plant wiring. You can use loop power in MEASURE, SOURCE, or MEASURE/SOURCE mode. Turn loop power on and off from the **SETUP** menu.

1. Connect the calibrator to the transmitter current loop terminals.
2. **SETUP**.
3. **▲▼** to highlight **Disabled after Loop Power**, **ENTER**.
4. Select **Enabled-24V** for 24V operation, or **Enabled-28V** for 28V operation.

NOTE

Most transmitters are designed for 24V operation, but some installations may require 28V.

5. **ENTER**.
6. To measure loop current at the same time that you are supplying loop power, press **mA** in MEASURE mode.

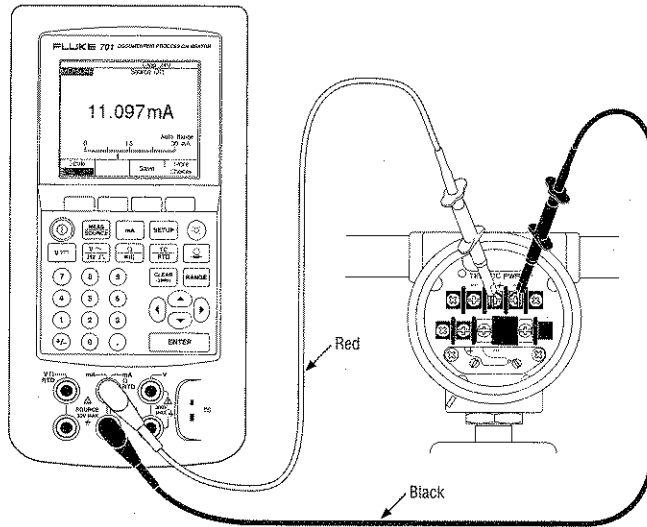

Using Setup Mode

Many operating parameters can be changed in **SETUP** mode. Some important ones are explained here. For a full reference to **SETUP**, see the *701/702 Users Manual*. The **SETUP** menu contains three screens as follows. Press the Next Page softkey to step through the screens.

Screen 1

SETUP			
Loop Power Disabled			
Ref. Junc. Compensat. Internal			
Auto Battery Save Off			
Battery Save Timeout 120 minutes			
Auto Backlight Off			
Backlight Timeout 1 minutes			
Choices	Prev. Page	Next Page	Done

Screen 2







SETUP			
Date Display Off			
Date 03/17/94			
Date Format 01/31/99			
Time Display Off			
Time 01:52:59 pm			
Time Format 12:00:00 am			
Numeric Format 9.000			
Choices	Prev. Page	Next Page	Done

Screen 3

SETUP			
Pressure Units PSI			
Temperature Units °C			
Temperature Scale ITS-90			
Language English			
ID CHUCK			
Choices	Prev. Page	Next Page	Done









Using the Battery Save Feature

The battery save feature turns the calibrator off after your choice of idle time. When battery save is enabled, the  indicator shows in reverse video.

1. .
2.  to select **Auto Battery Save**.
3.  or **Choices**.
4.  to select **On** or **Off**.
5. .
6.  to select **Battery Save Timeout**.
7. Numeric keypad to enter minutes.
8. .

Using the Backlight Timeout Feature

The backlight save feature turns the backlight off after your choice of idle time. When backlight save is enabled, the  indicator shows in reverse video.

1. .
2.  to select **Auto Backlight Off**.
3.  or **Choices**.
4.  to select **On** or **Off**.
5. .
6.  to select **Backlight Timeout**. .
7. Numeric keypad to enter minutes.
8. .

Selecting the Display Language

1. .
2. Softkey 3 twice.
3. three times.
4. .
5. to select your choice of language.
6. .

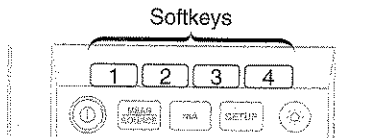

Selecting Date Format

1. .
2. **Next Page.**
3. to select **Date Format.**
4. .
5. for desired date format.
6. .

SERVICE

For service information, call 1-800-825-9810 (USA and Canada). From other countries, contact the nearest Fluke Service Center.

For application or operation assistance or information on Fluke products, call:

800-44-FLUKE in USA and Canada

(31 40) 723330 in Europe

206-356-5500 from other countries

Fluke Corporation, P.O. Box 9090 Everett, WA 98206-9090

Fluke Europe B.V., P.O.Box 1186, 5602 BD Eindhoven, The Netherlands