

7. CIRCUIT DIAGRAM

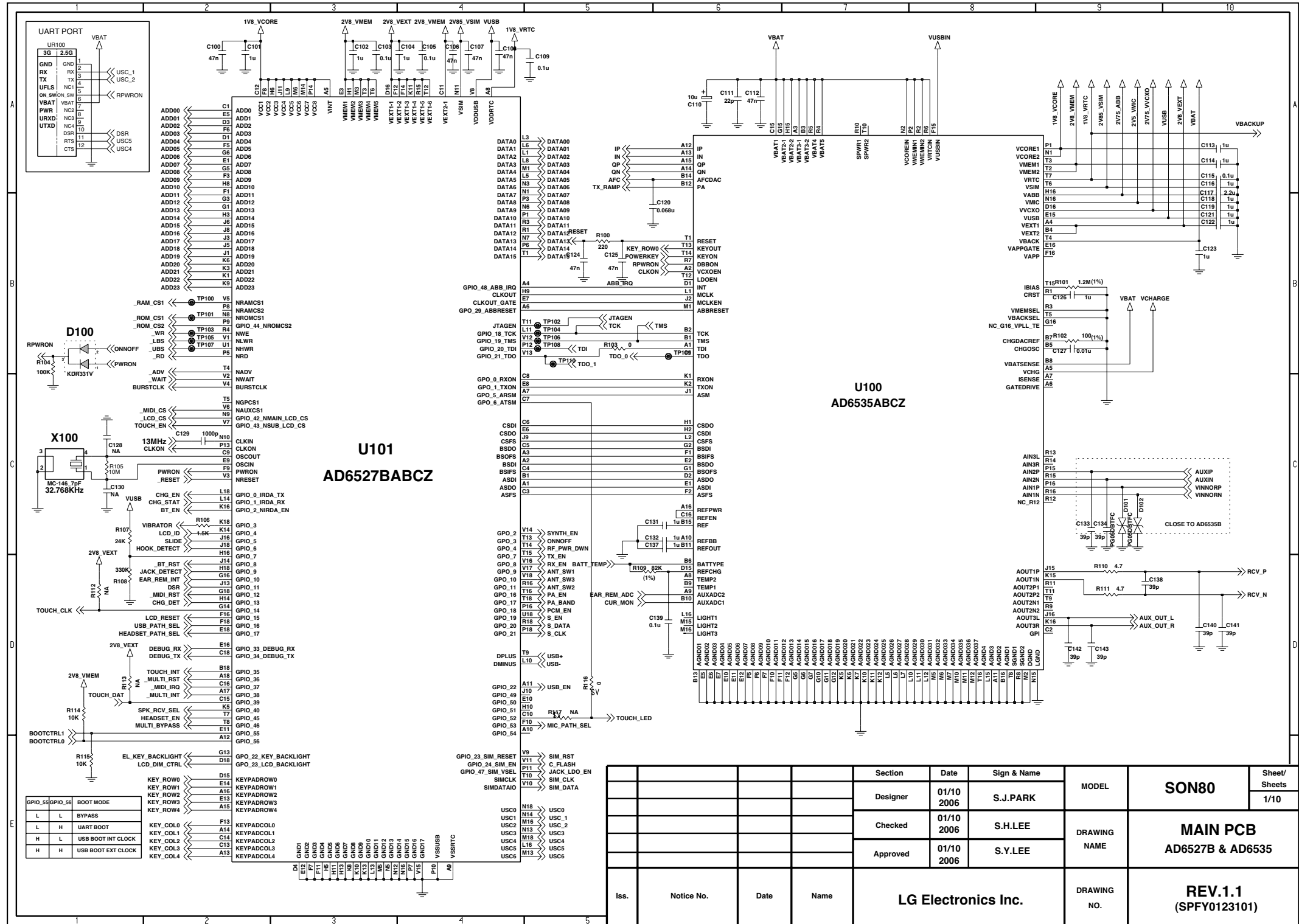

7. CIRCUIT DIAGRAM

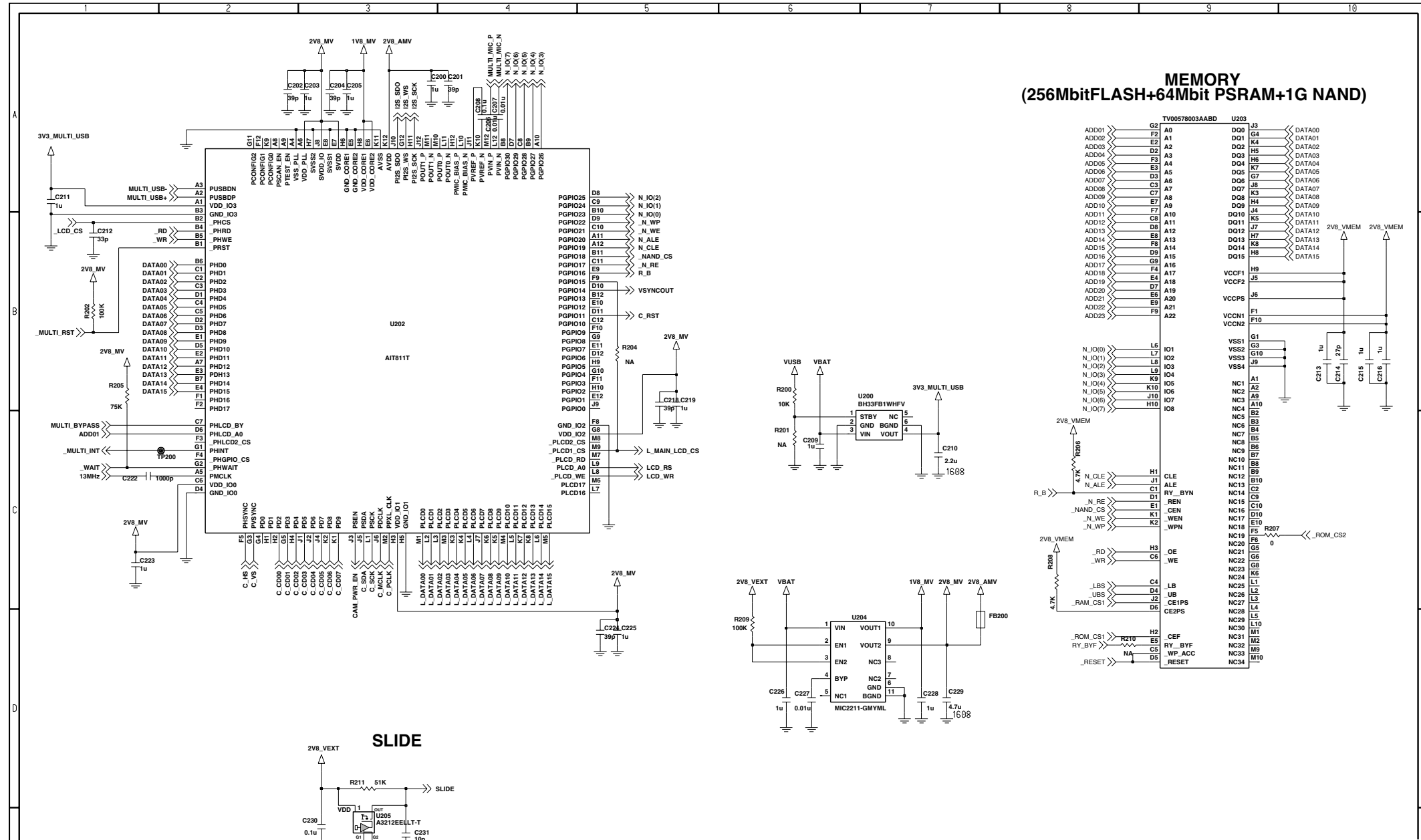

Section	Date	Sign & Name	MODEL	Sheet/ Sheets	
Designer	01/10 2006	S.J.PARK	SON80	2/10	
Checked	01/10 2006	S.H.LEE	DRAWING NAME	MAIN PCB (MEMORY, AIT, NAND, CHARGING IC)	
Approved	01/10 2006	S.Y.LEE			
Iss.	Notice No.	Date	Name	DRAWING NO.	REV.1.1 (SPFY0123101)

7. CIRCUIT DIAGRAM

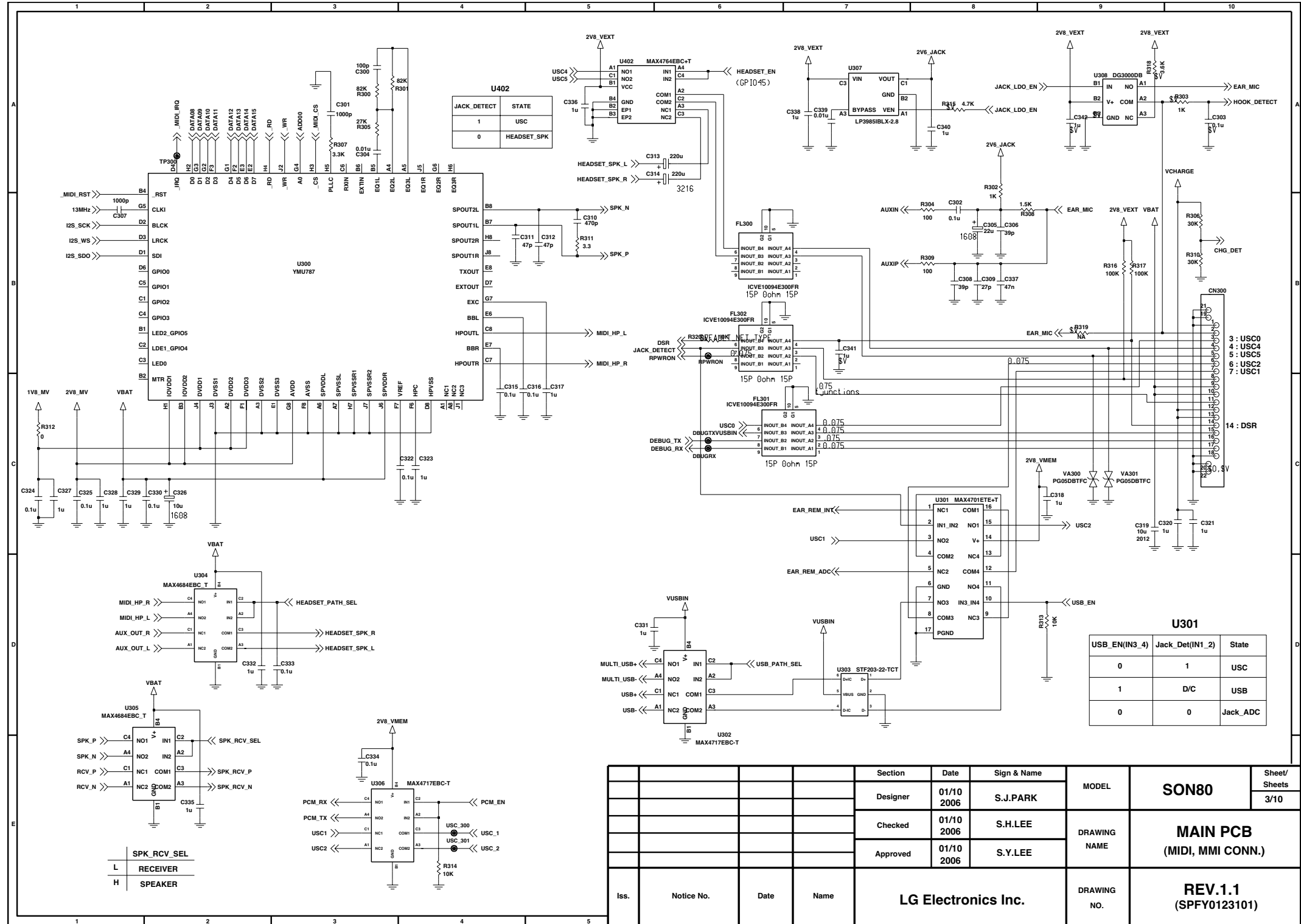

LGIC(42)-A-5505-10:01

LG Electronics Inc.

Section	Date	Sign & Name	MODEL	Sheet/ Sheets	
Designer	01/10 2006	S.J.PARK	SON80	3/10	
Checked	01/10 2006	S.H.LEE	DRAWING NAME	MAIN PCB (MIDI, MMI CONN.)	
Approved	01/10 2006	S.Y.LEE			
Iss.	Notice No.	Date	Name	DRAWING NO.	REV.1.1 (SPFY0123101)
			LG Electronics Inc.		

7. CIRCUIT DIAGRAM

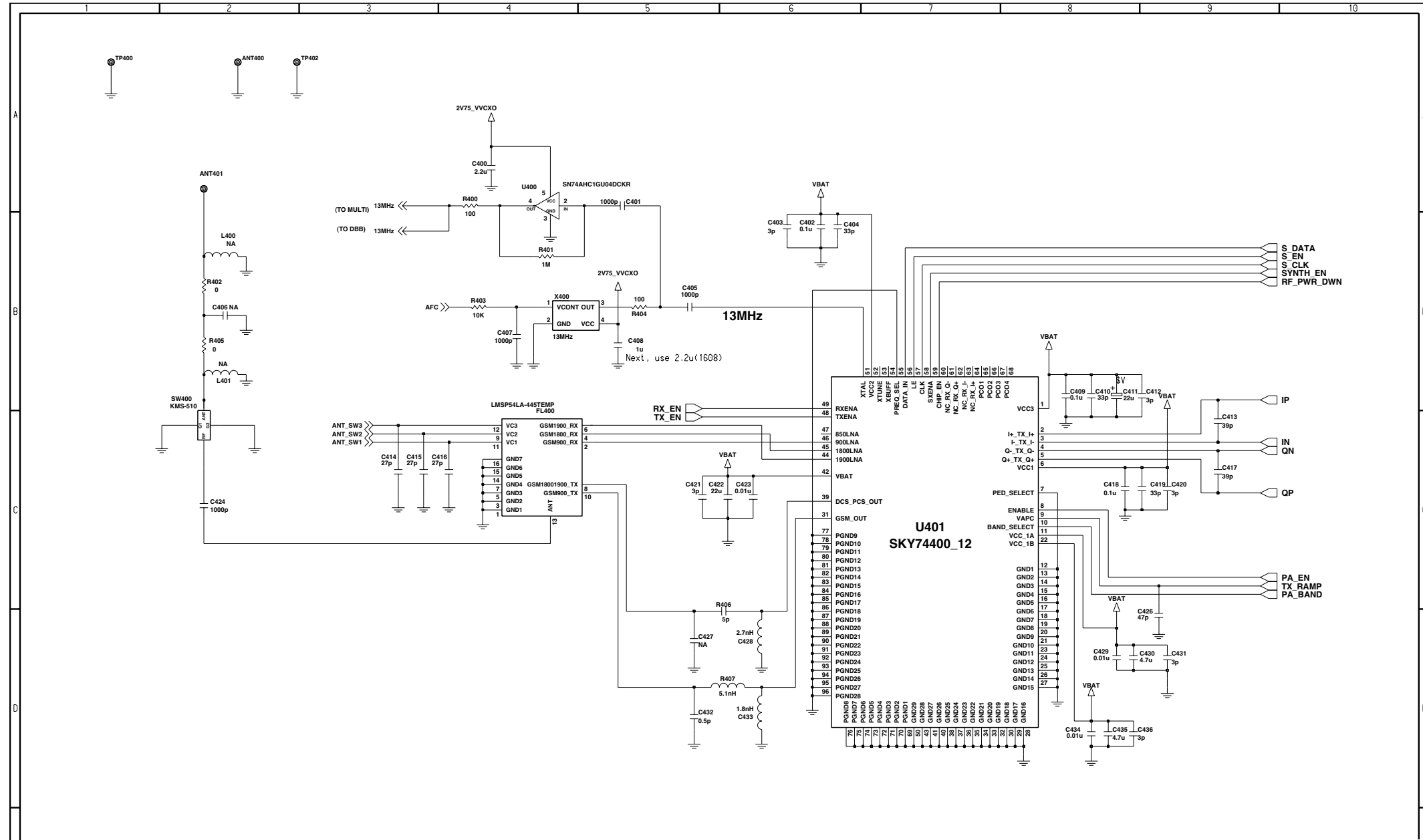

				Section	Date	Sign & Name	MODEL	SON80	Sheet/ Sheets
				Designer	01/10 2006	H.C.LIM			
				Checked	01/10 2006	K.U.PARK	DRAWING NAME	MAIN PCB (RF)	
				Approved	01/10 2006	S.Y.LEE			
Iss.	Notice No.	Date	Name	LG Electronics Inc.			DRAWING NO.	REV.1.1 (SPFY0123101)	

7. CIRCUIT DIAGRAM

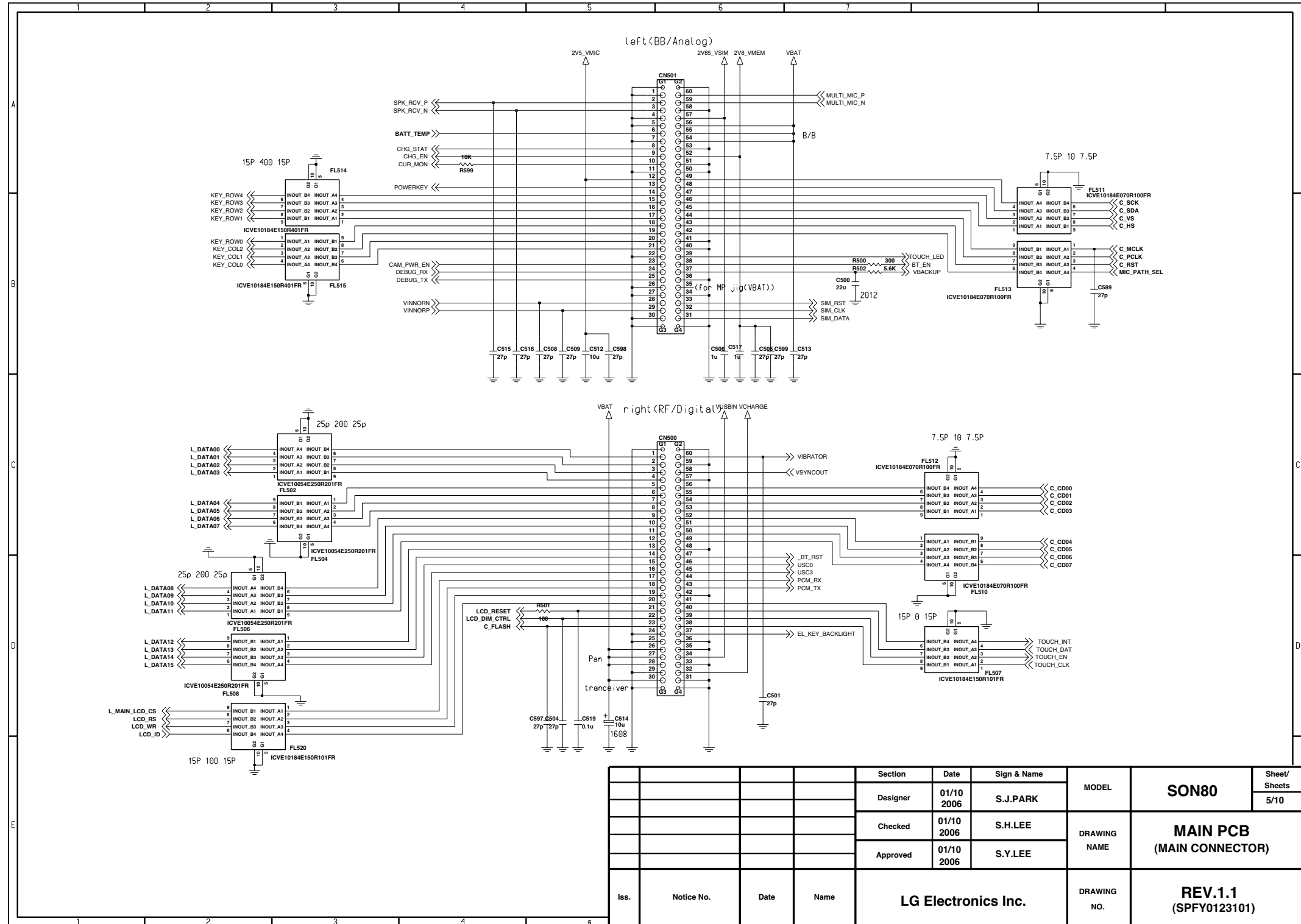

Section	Date	Sign & Name	MODEL	SON80	Sheet/ Sheets 5/10
Designer	01/10 2006	S.J.PARK			
Checked	01/10 2006	S.H.LEE	DRAWING NAME	MAIN PCB (MAIN CONNECTOR)	
Approved	01/10 2006	S.Y.LEE			
Iss.	Notice No.	Date	Name	DRAWING NO.	
LG Electronics Inc.				REV.1.1 (SPFY0123101)	

7. CIRCUIT DIAGRAM

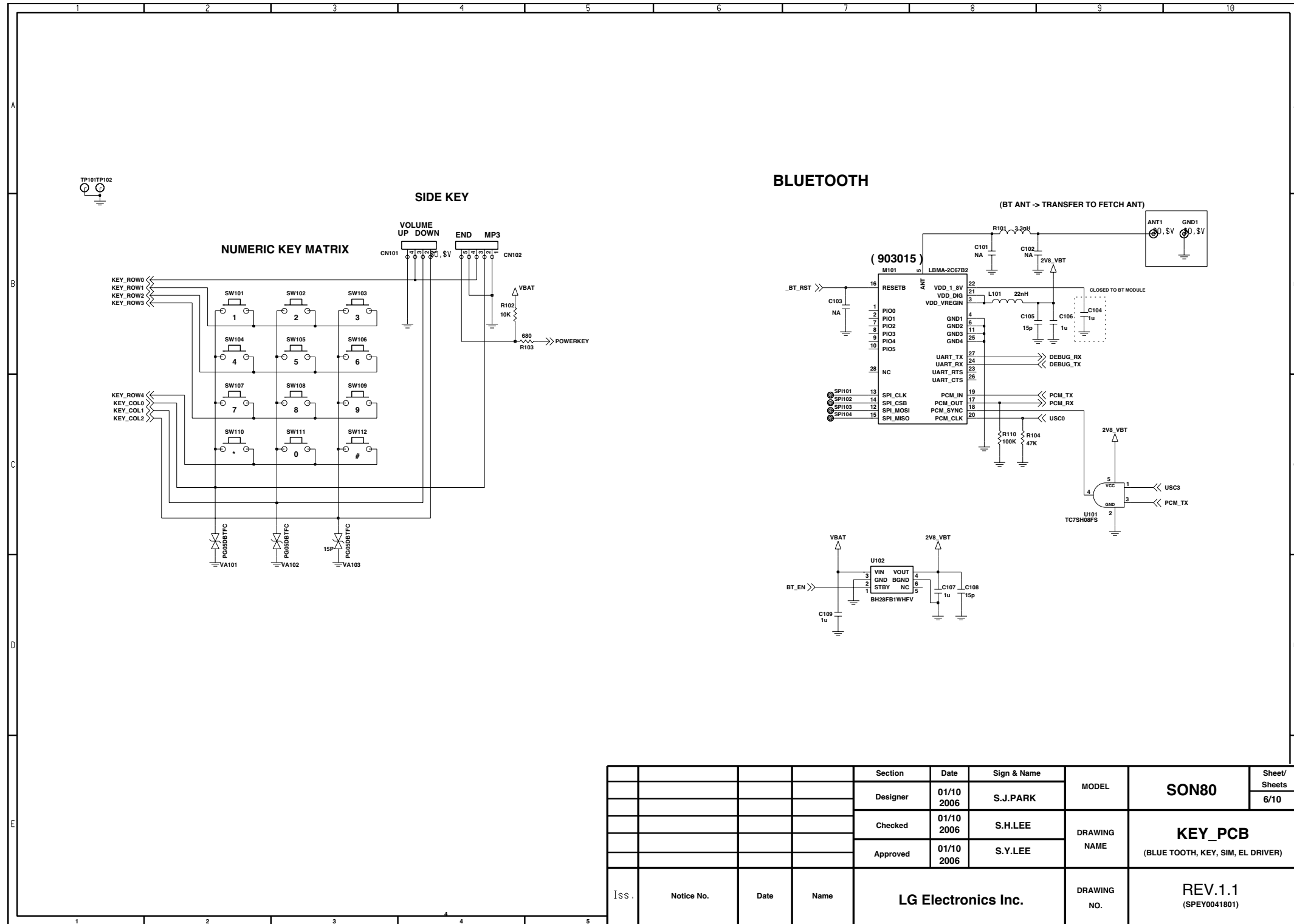

				Section	Date	Sign & Name	MODEL	SON80	Sheet/
				Designer	01/10 2006	S.J.PARK			
				Checked	01/10 2006	S.H.LEE	DRAWING NAME	KEY_PCB (BLUE TOOTH, KEY, SIM, EL DRIVER)	6/10
				Approved	01/10 2006	S.Y.LEE			
Iss.	Notice No.	Date	Name	LG Electronics Inc.			DRAWING NO.	REV.1.1 (SPEY0041801)	

7. CIRCUIT DIAGRAM

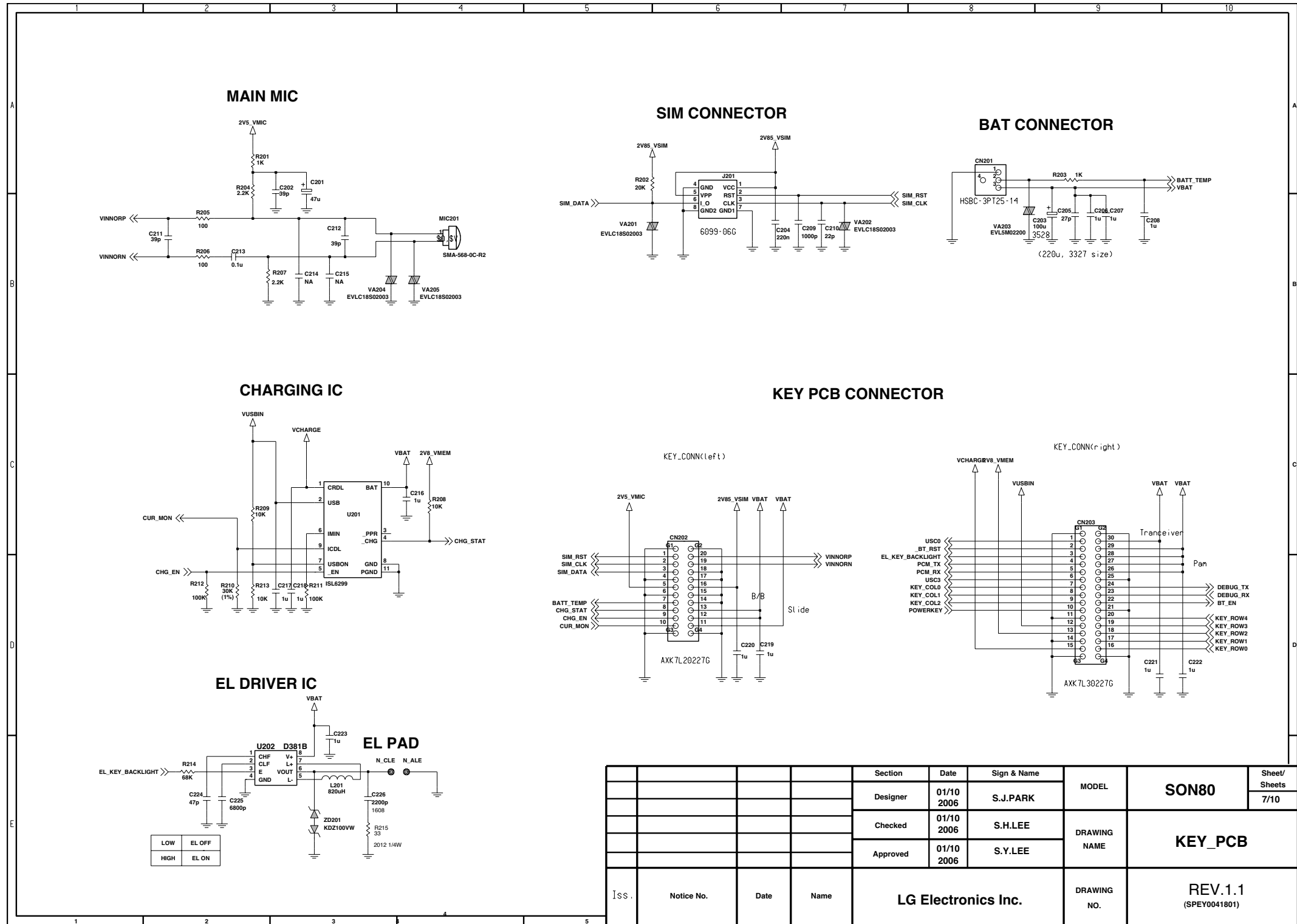

LGIC(42)-A-5505-10:01

LG Electronics Inc.

7. CIRCUIT DIAGRAM

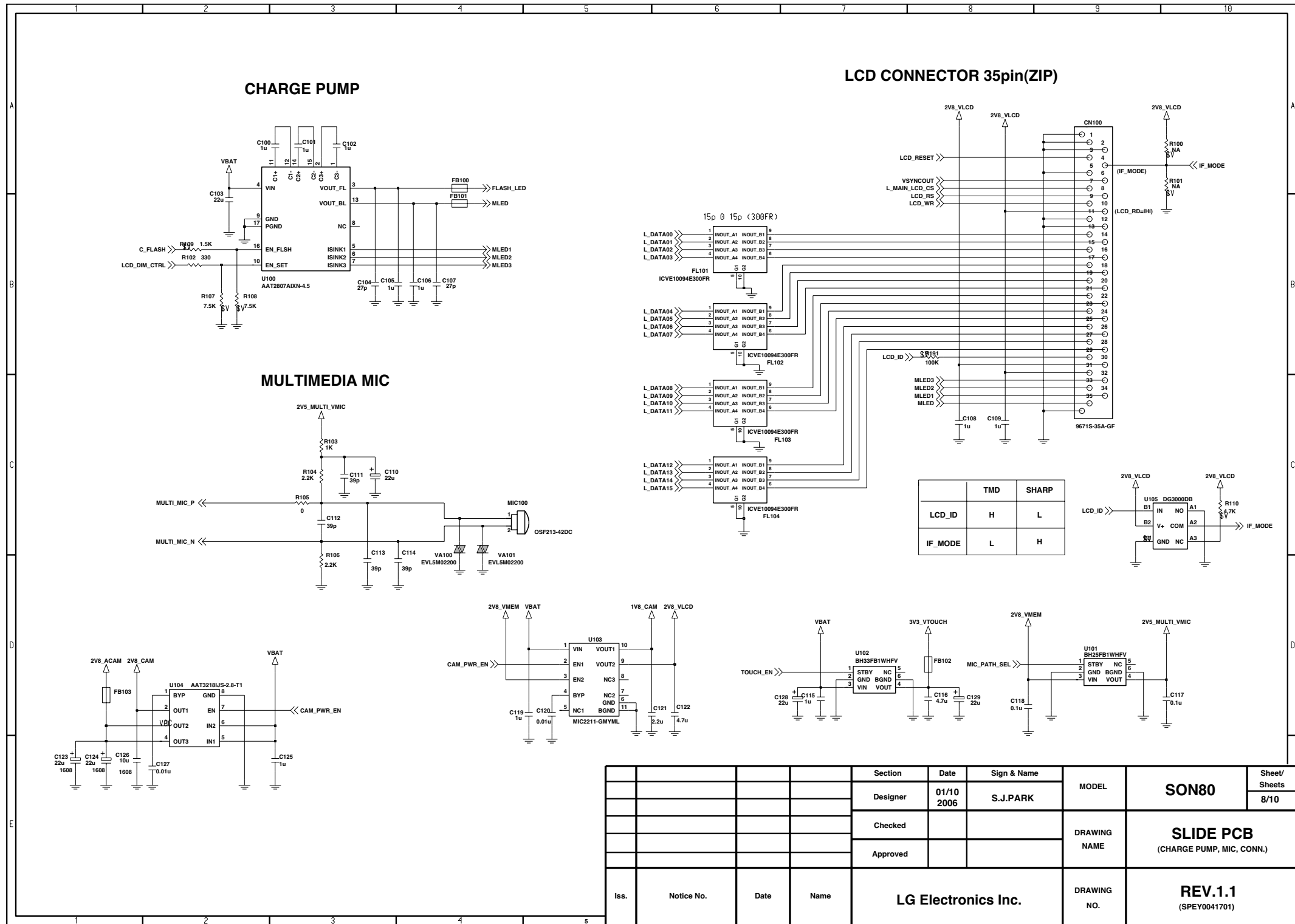

7. CIRCUIT DIAGRAM

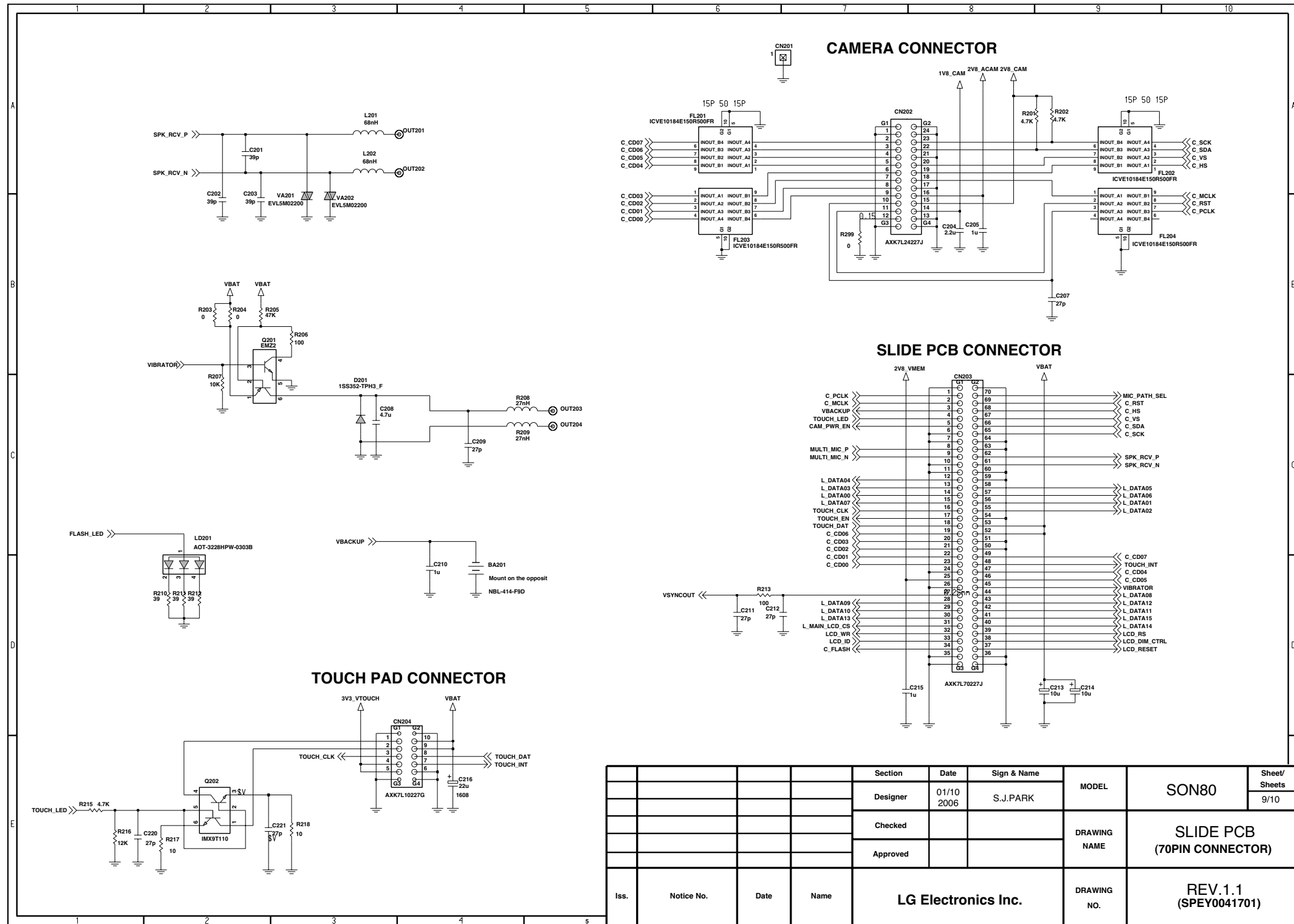

Section	Date	Sign & Name	MODEL	SON80	Sheet/ Sheets
Designer	01/10 2006	S.J.PARK			9/10
Checked			DRAWING NAME	SLIDE PCB (70PIN CONNECTOR)	
Approved			DRAWING NO.	REV.1.1 (SPEY0041701)	
Iss.	Notice No.	Date	Name	LG Electronics Inc.	

7. CIRCUIT DIAGRAM

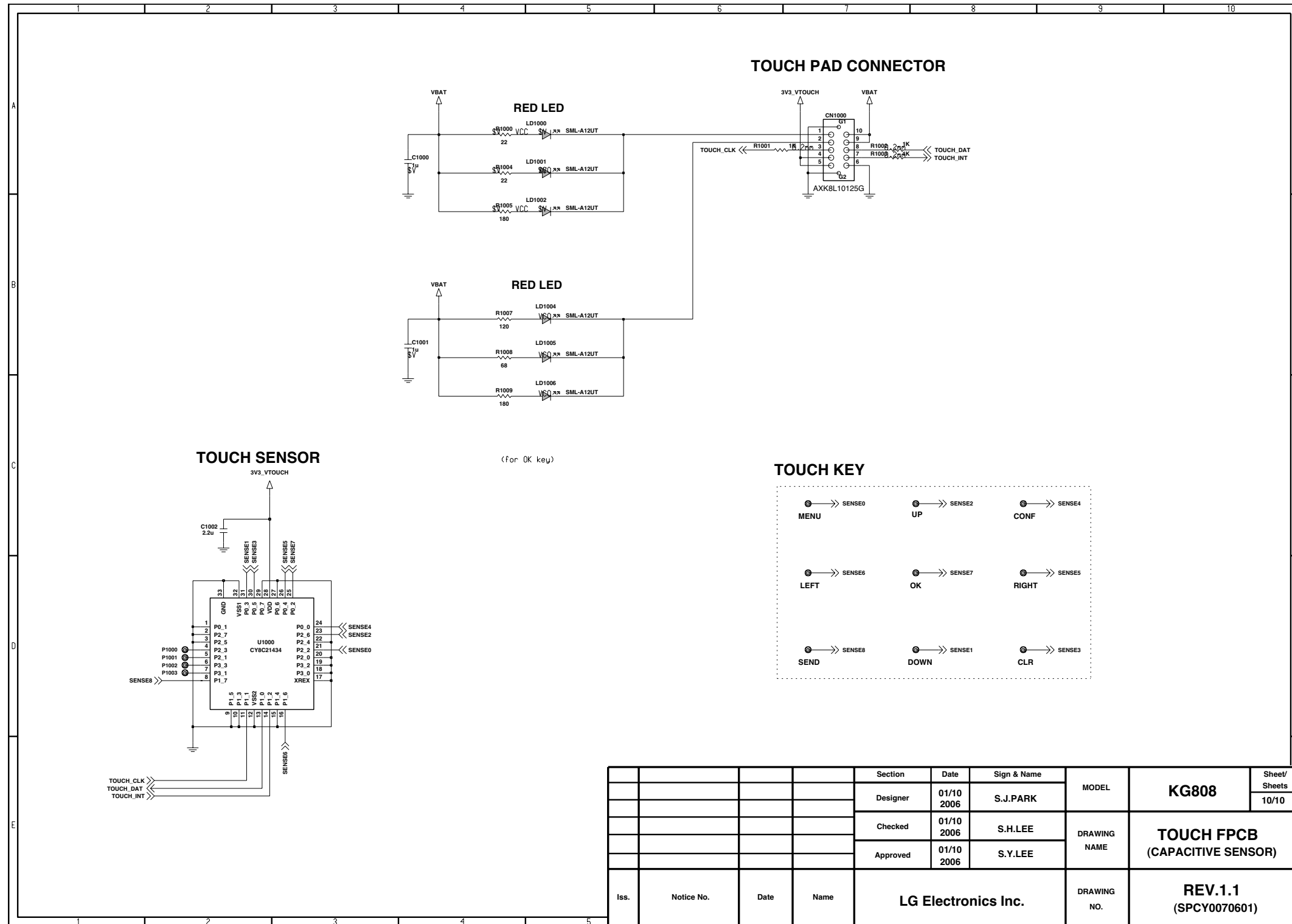

				Section	Date	Sign & Name	MODEL	KG808	Sheet/ Sheets
				Designer	01/10 2006	S.J.PARK			10/10
				Checked	01/10 2006	S.H.LEE	DRAWING NAME	TOUCH FPCB (CAPACITIVE SENSOR)	
				Approved	01/10 2006	S.Y.LEE			
Iss.	Notice No.	Date	Name	LG Electronics Inc.			DRAWING NO.	REV.1.1 (SPCY0070601)	

7. CIRCUIT DIAGRAM

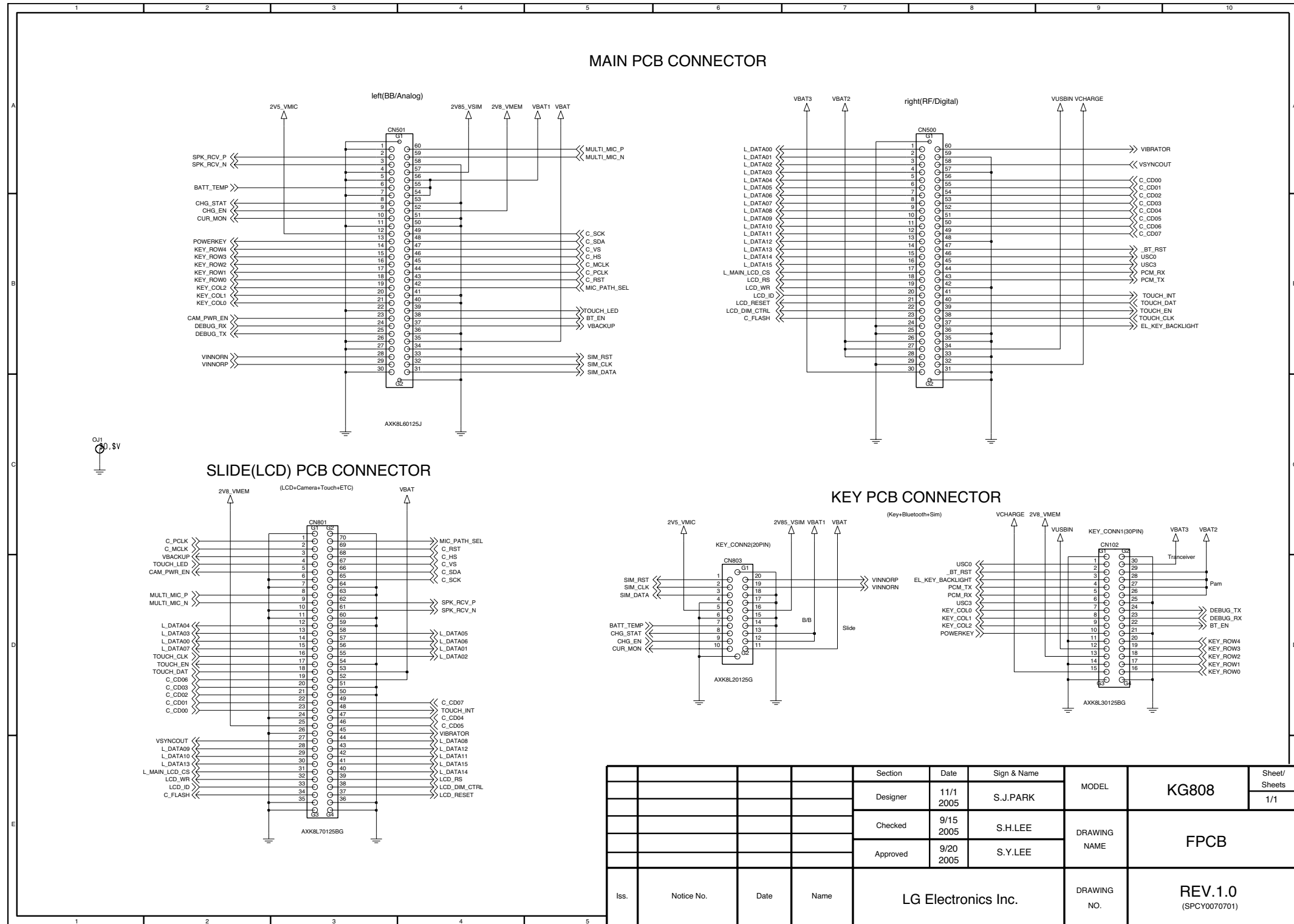

Section	Date	Sign & Name	MODEL	KG808	Sheet/ Sheets
Designer	11/1 2005	S.J.PARK			1/1
Checked	9/15 2005	S.H.LEE	DRAWING	FPCB	
Approved	9/20 2005	S.Y.LEE	NAME		
Iss.	Notice No.	Date	Name	LG Electronics Inc.	DRAWING NO.
					REV.1.0 (SPCY0070701)

7. CIRCUIT DIAGRAM

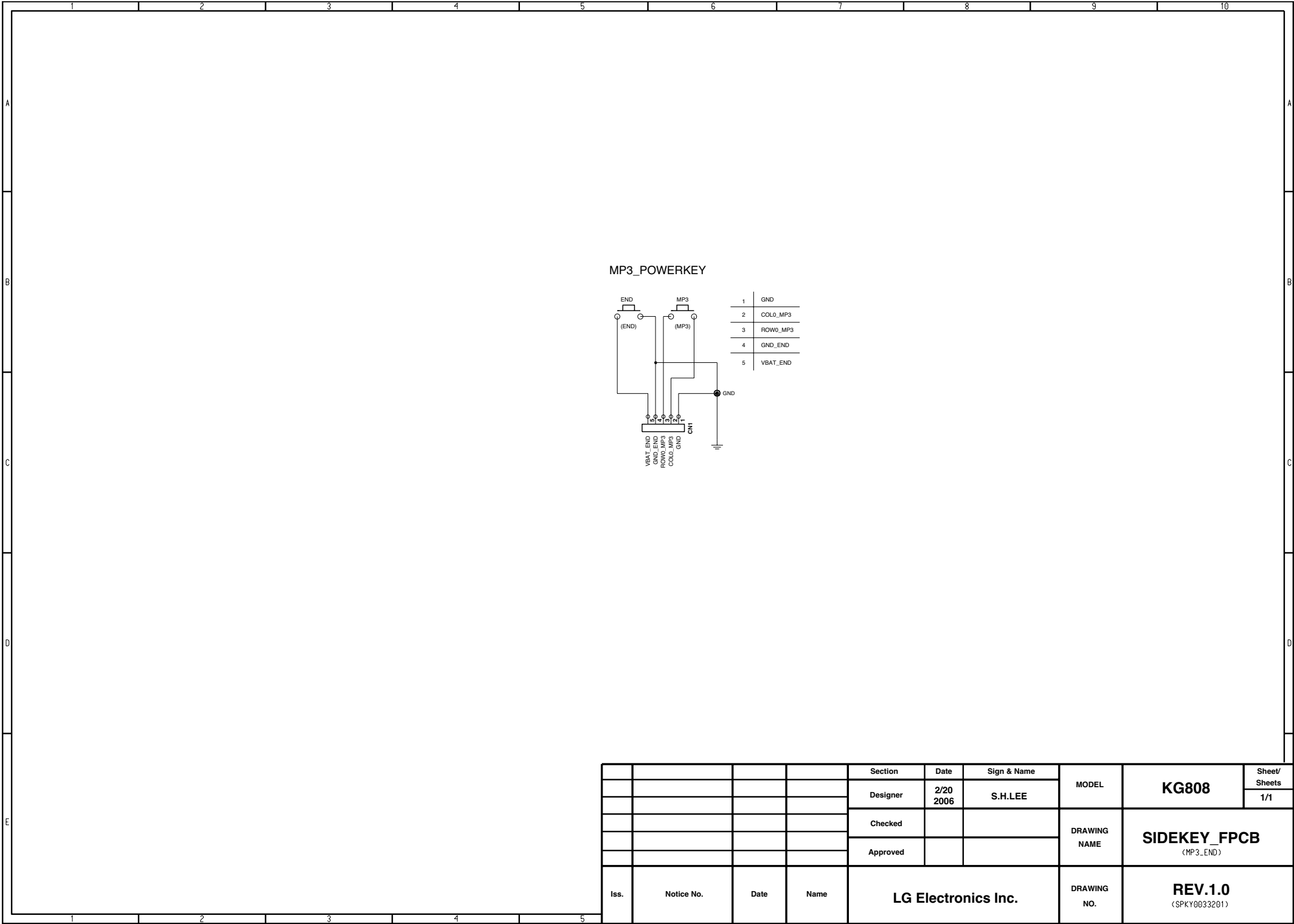

				Section	Date	Sign & Name	MODEL	KG808	Sheet/ Sheets
				Designer	2/20 2006	S.H.LEE			1/1
				Checked			DRAWING NAME	SIDEKEY_FPCB (MP3_END)	
				Approved					
Iss.	Notice No.	Date	Name	LG Electronics Inc.			DRAWING NO.	REV.1.0 (SPKY0033201)	

7. CIRCUIT DIAGRAM

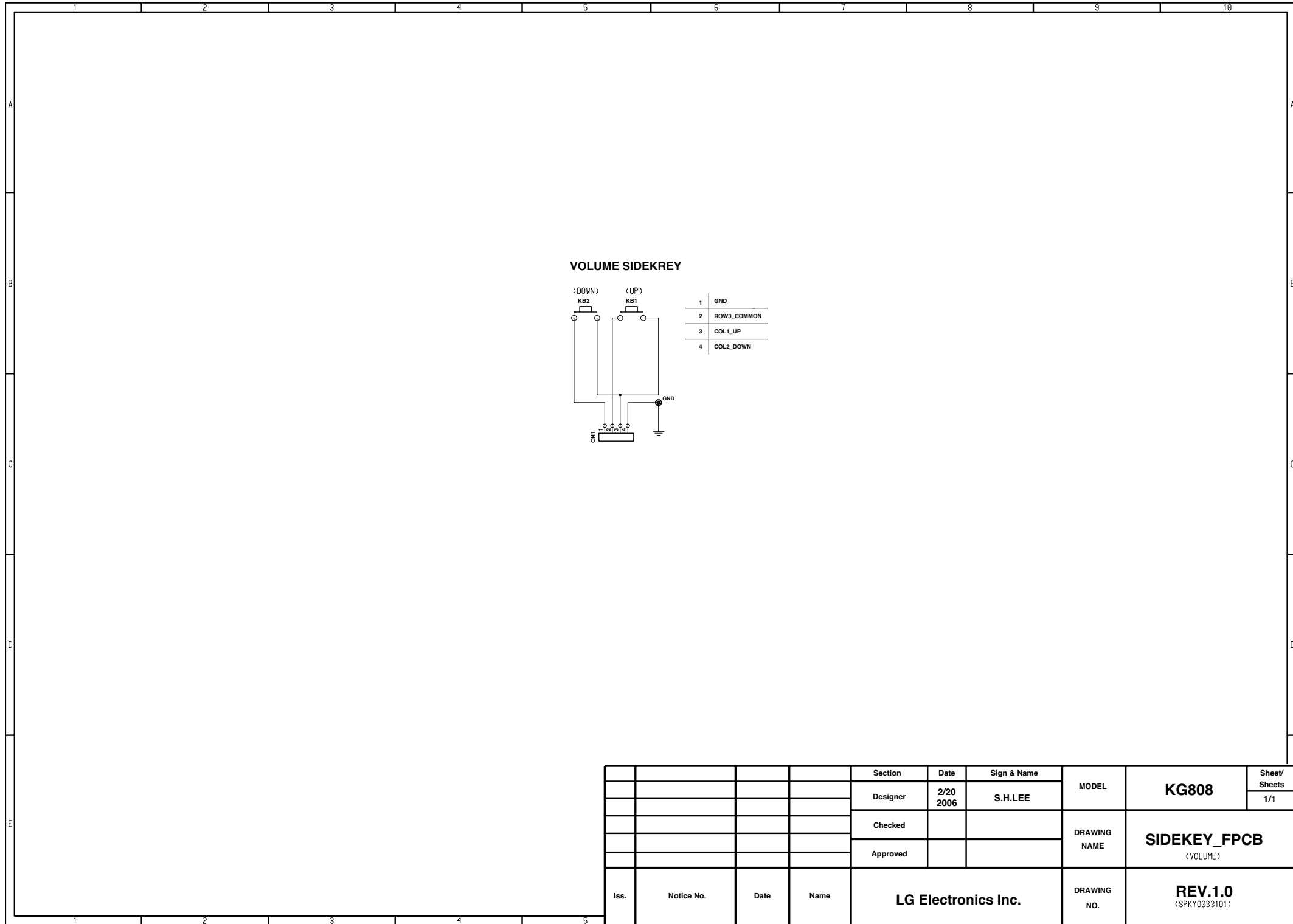

				Section	Date	Sign & Name	MODEL	KG808	Sheet/ Sheets
				Designer	2/20 2006	S.H.LEE			1/1
				Checked			DRAWING NAME	SIDEKEY_FPCB (VOLUME)	
				Approved					
Iss.	Notice No.	Date	Name	LG Electronics Inc.			DRAWING NO.	REV.1.0 (SPKY0033101)	

8. PCB LAYOUT

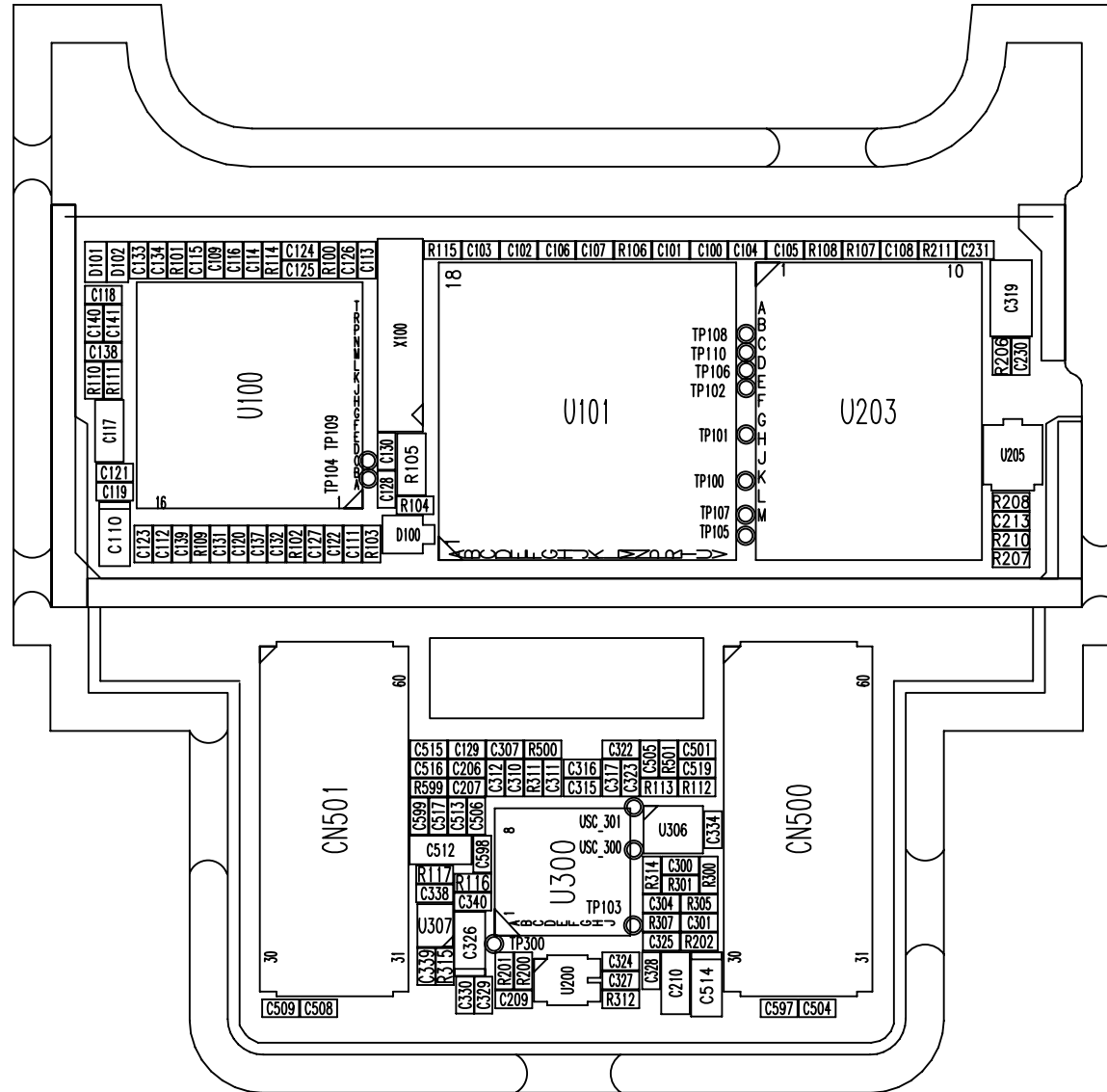

KG808-SPFY0123101-1.1-TOP

8. PCB LAYOUT

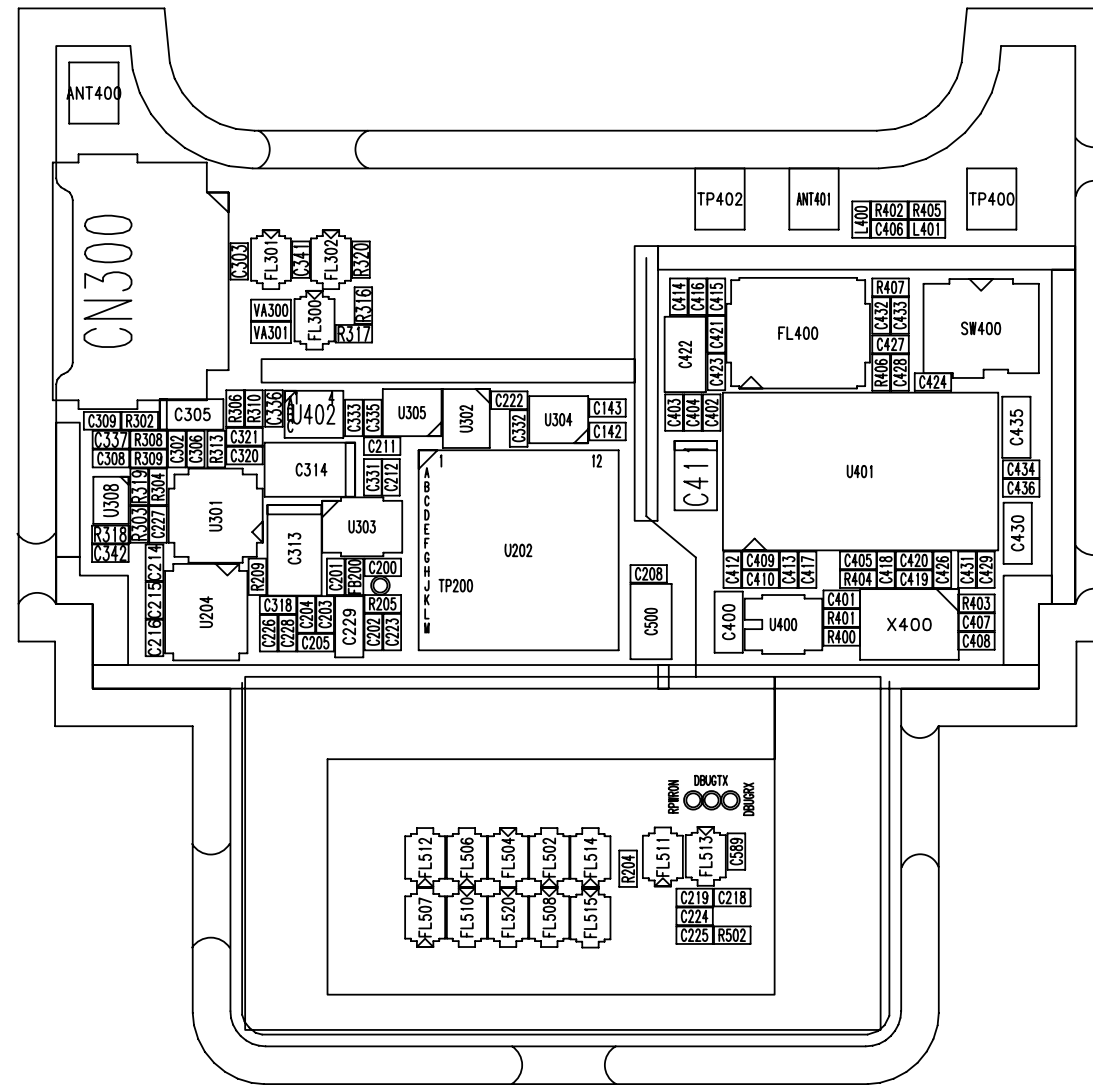

KG808-SPFY0123101-1.1-BTM

8. PCB LAYOUT

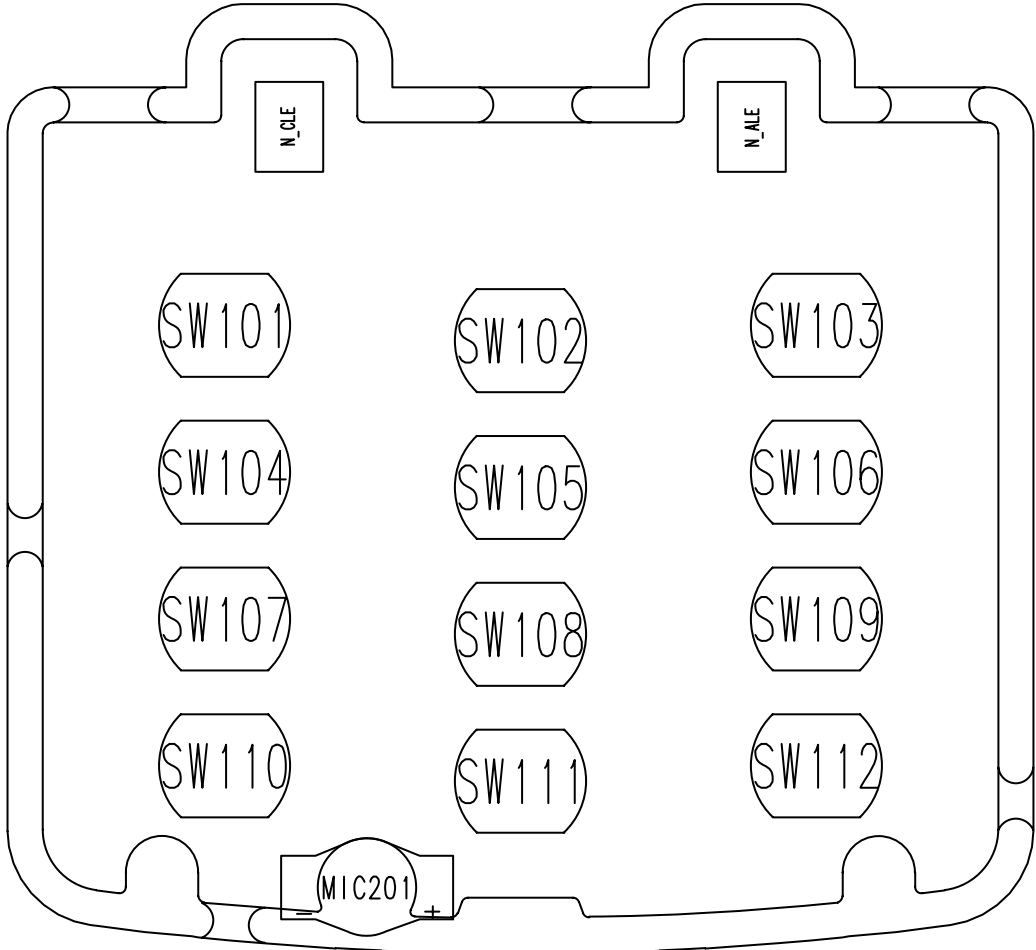

KG90/KG800/MG800c-KEY-1.1-TOP

8. PCB LAYOUT

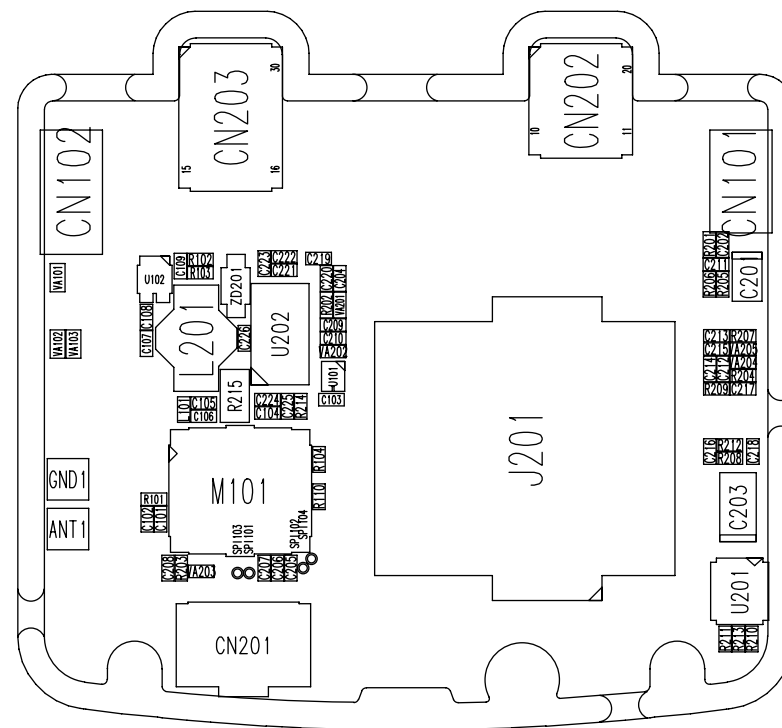

KG90/KG800/MG800c-KEY-1.1-BTM

8. PCB LAYOUT

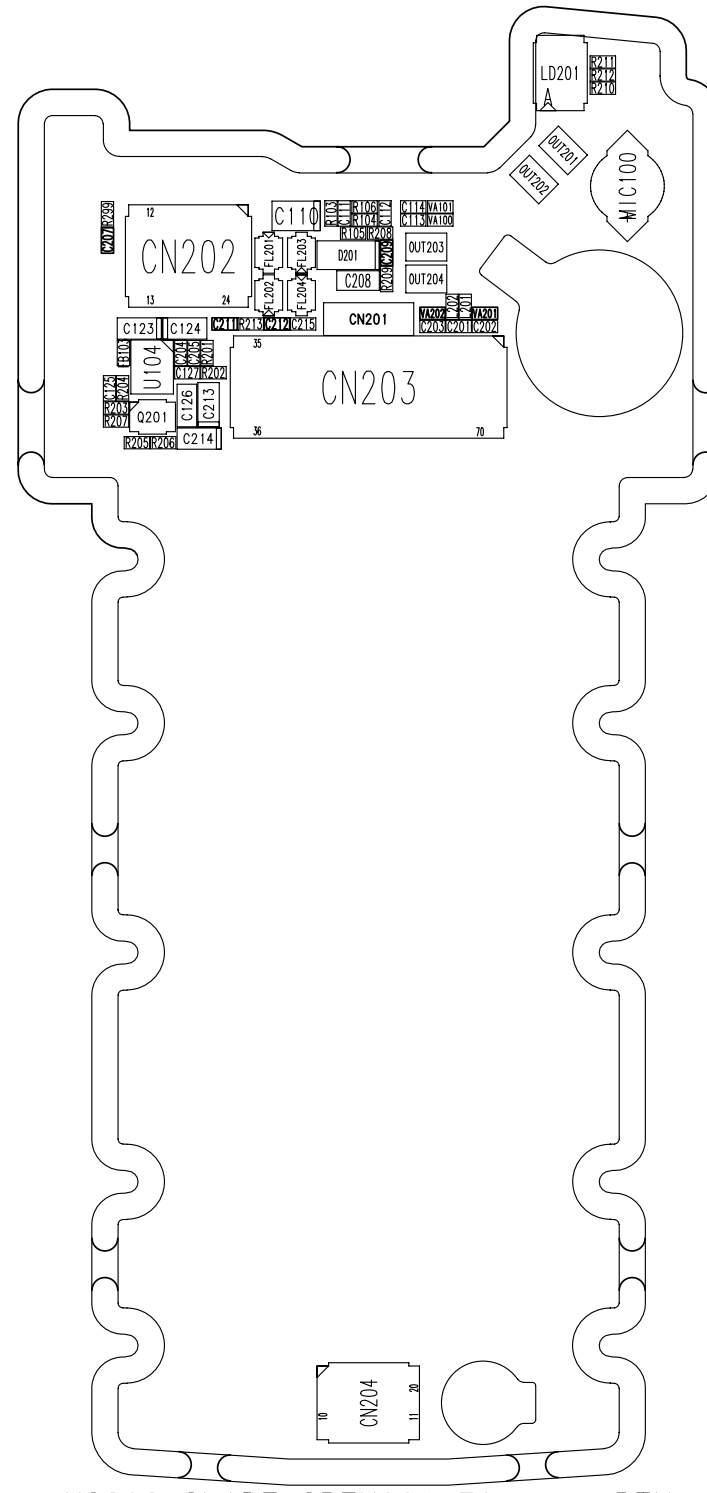

KG808 SLIDE SPEY0041701-1.1-BTM

8. PCB LAYOUT

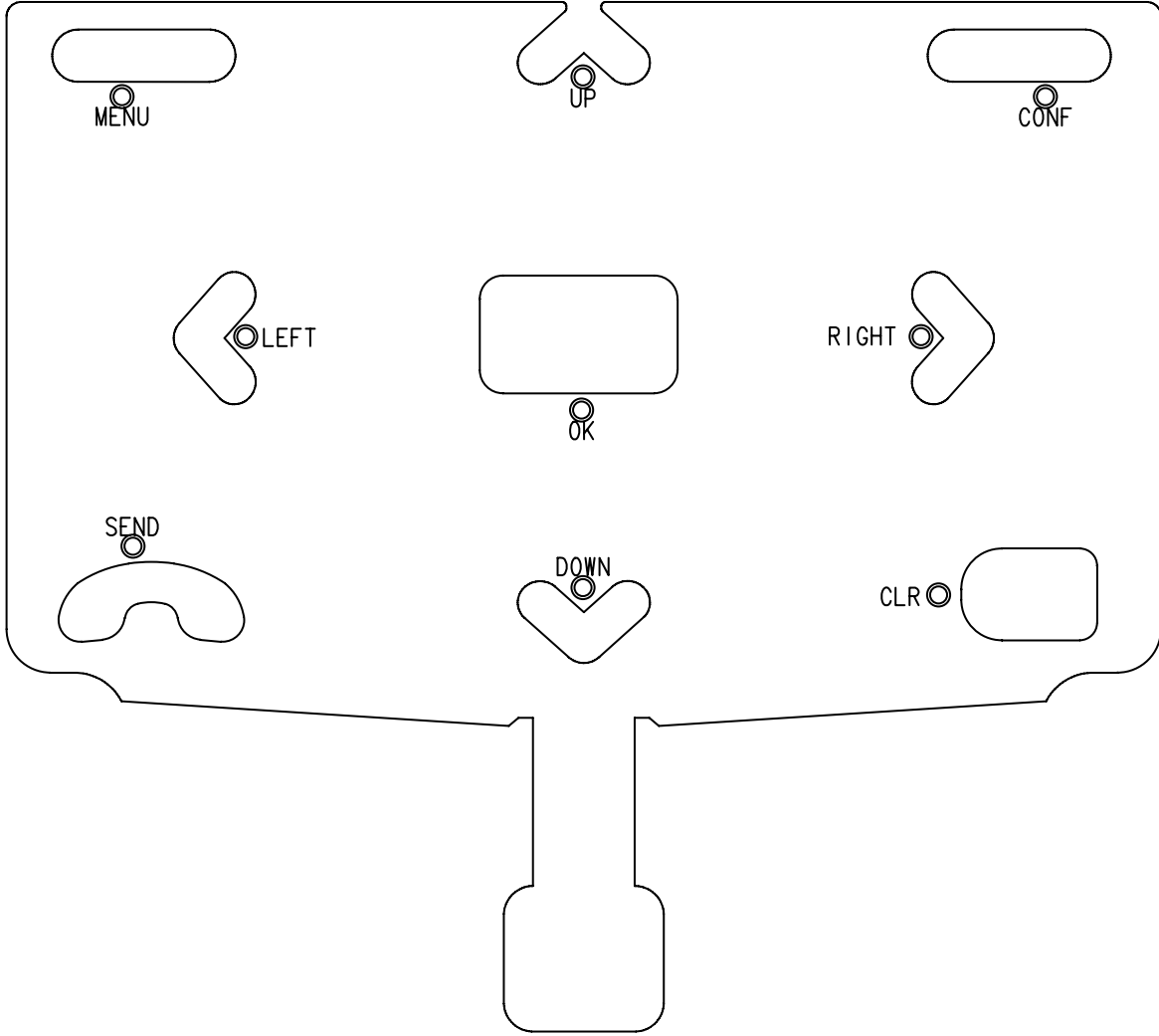

KG808-TOUCH-1.1-TOP

8. PCB LAYOUT

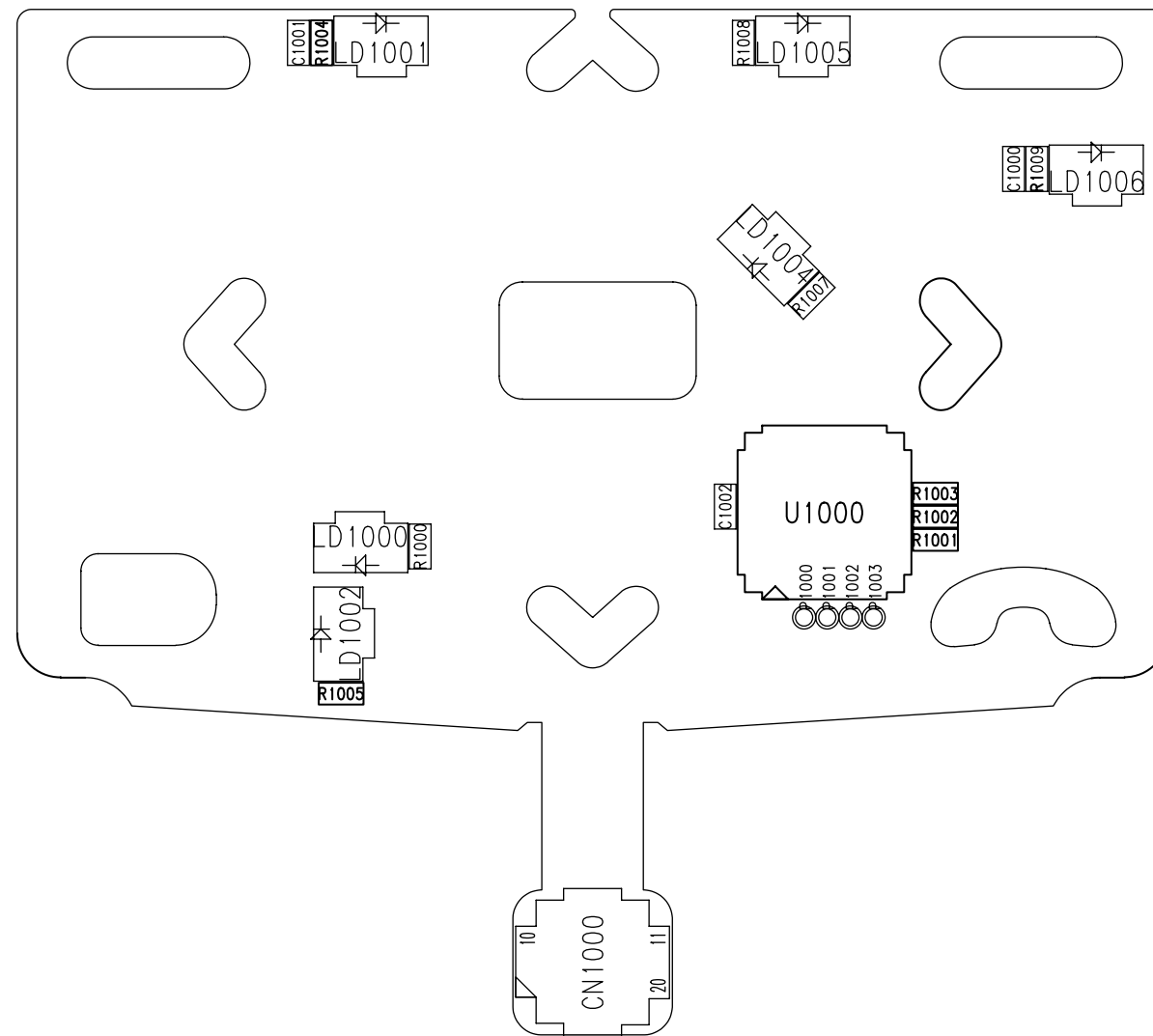

KG808-TOUCH-1.1-BTM

8. PCB LAYOUT

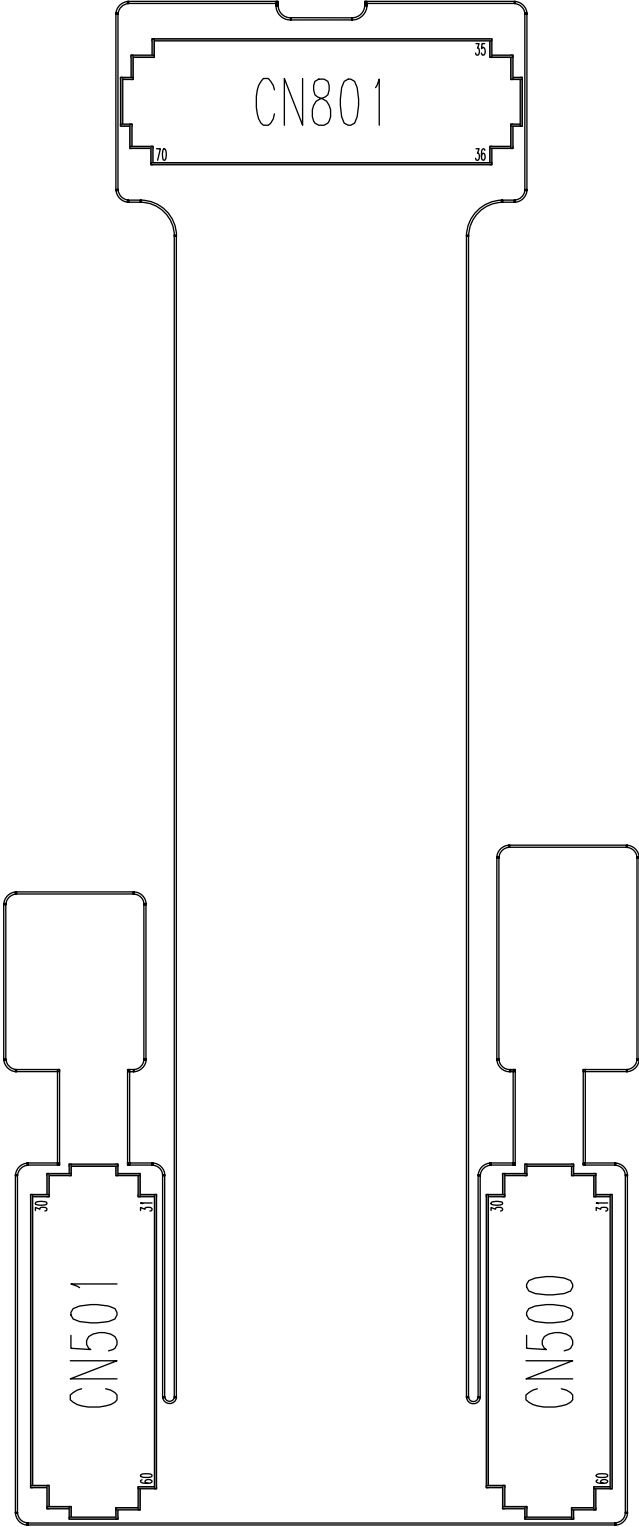

KG808-MAIN_FPCB-1.0-TOP

8. PCB LAYOUT

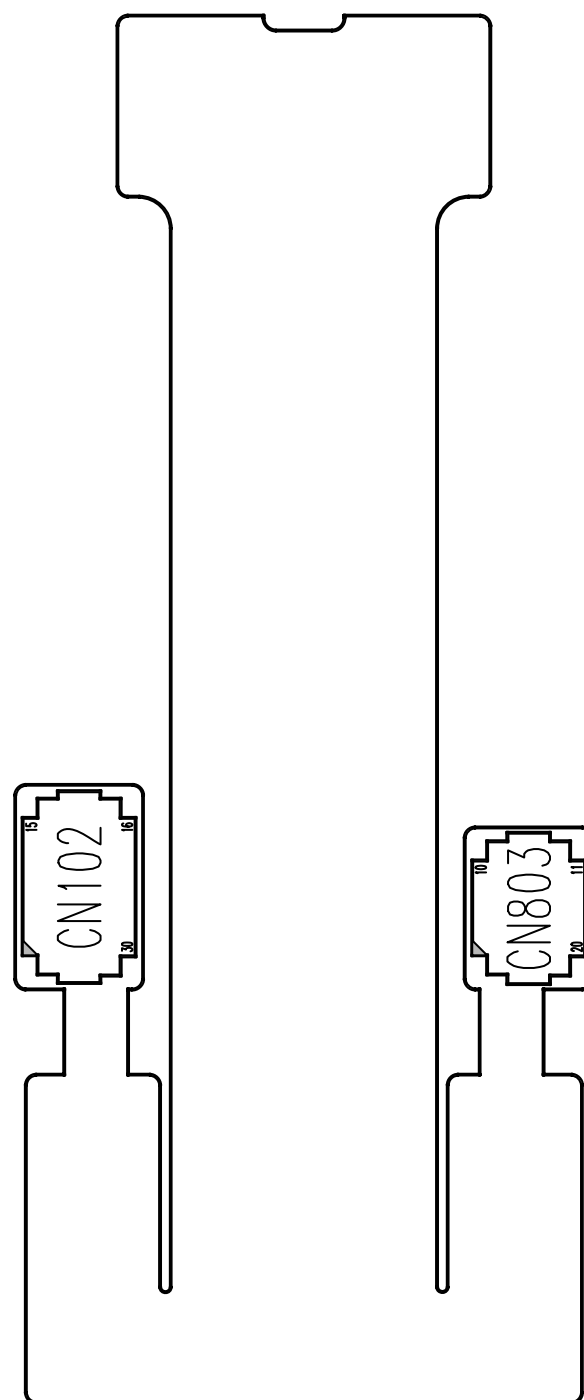

KG808-MAIN_FPCB-1.0-BTM

8. PCB LAYOUT



KG808-SPKY0033201-MP3-1.0-TOP

8. PCB LAYOUT

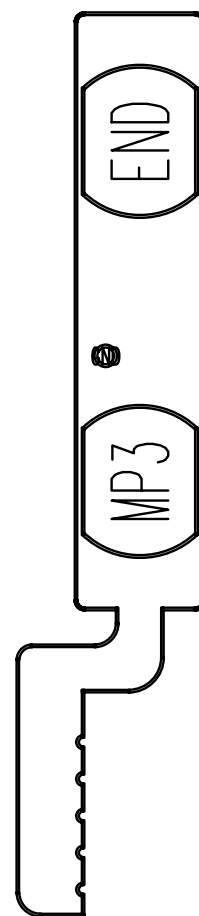

KG808-SPKY0033201-MP3-1.0-BTM

8. PCB LAYOUT

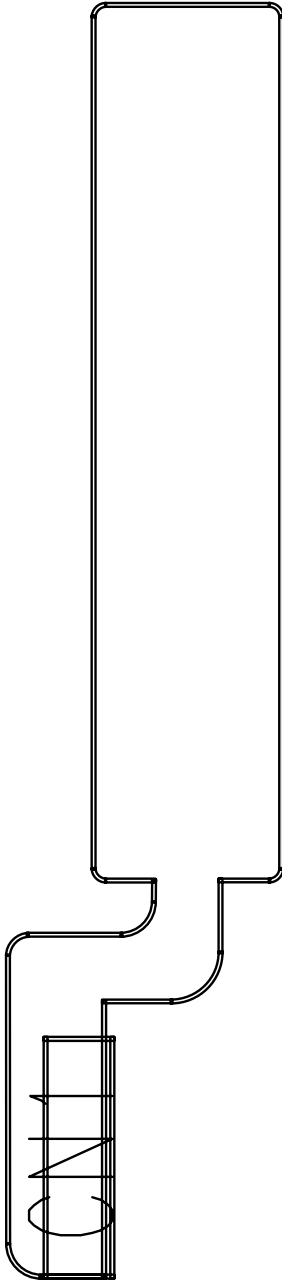

KG808-SPKY0033101-VOL-1.0-TOP

8. PCB LAYOUT

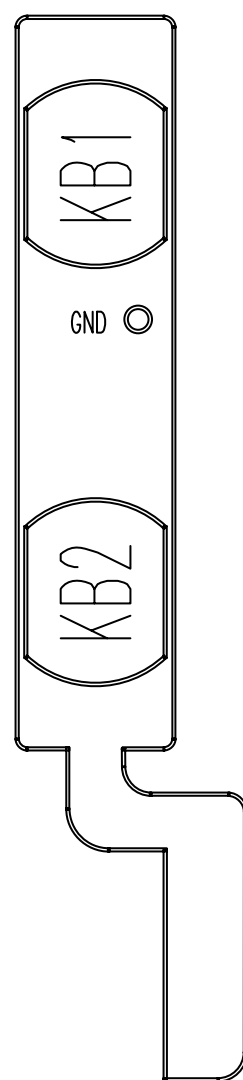

KG808-SPKY0033101-VOL-1.0-BTM