

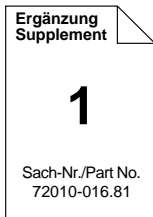

Ⓓ Btx \* 32700 #

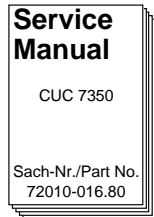

**Zusätzlich erforderliche Unterlagen für den Komplettservice:**  
**Additionally required Service Manuals for the Complete Service:**



## CUC 7350

|                               |                             |                            |                             |
|-------------------------------|-----------------------------|----------------------------|-----------------------------|
| <b>Greenville SP 737 text</b> | (9.21416-01 / G.CB 9975)    | <b>ST 55-750/9 text</b>    | (9.21347-02 / G.CB 0775)    |
| <b>Lissabon SE 5576 text</b>  | (9.21434-01 / G.CB 5475)    | Small neck Bildröhre / CRT |                             |
| Small neck Bildröhre / CRT    |                             | <b>ST 55-725 FT/GB</b>     | (9.21539-64 / G.CD 9975 GB) |
| <b>ST 55-876/9 text</b>       | (9.21436-11 / G.CB 5375 FB) | Small neck Bildröhre / CRT |                             |
| Small neck Bildröhre / CRT    |                             | <b>XS 55/1</b>             | (9.21378-01 / G.CB 9675)    |
| <b>ST 55-750 text</b>         | (9.21347-01 / G.CB 0275)    | <b>XS 55/9</b>             | (9.21378-02 / G.CB 9775)    |
| Small neck Bildröhre / CRT    |                             |                            |                             |

Ⓓ

Im Laufe der Serie werden alle oben aufgeführten Geräte außer Greenville SP 737 text, XS 55/1, XS 55/9 von mini neck auf small neck Bildröhren umgestellt.  
Diese Geräte können Sie an dem dunkleren Bildschirm und einer anderen Bildrohrplatte erkennen.

Für diese Geräte gilt das Service Manual CUC 7350.  
Diese Ergänzung dokumentiert die Unterschiede bzw. zusätzlichen Bestückungen der Geräte.  
Die Bausteinbestückung und die Sachnummern der einzelnen Bausteine entnehmen Sie bitte der Tabelle auf Seite 2.  
Grundlage für den Service sind:  
– Sicherheitsvorschriften (Sach-Nr. 72010-800.00)  
– Service Manual CUC 7350 (Sach-Nr. 72010-016.80)

Ⓓ GB

In the course of this series all models listed above, except for Greenville SP 737 text, XS 55/1, XS 55/9, are being fitted with the small neck picture tube instead of the mini neck picture tube.  
These models can be identified by the darker screen and the different picture tube panel.

For these TV sets the Service Manual CUC 7350 is applicable.  
This Manual describes the differences and the additionally fitted modules of the TV receivers.  
The individual modules and the relevant part numbers are listed in the table on page 2.  
Basic instructions for servicing are given in the:  
– Safety Instructions (Part No. 72010-800.00)  
– Service Manual CUC 7350 (Part No. 72010-016.80)

**Inhaltsverzeichnis**

|                                       | <b>Seite</b> |
|---------------------------------------|--------------|
| Modulübersicht .....                  | 2            |
| Technische Daten .....                | 3            |
| Videotext-Baustein 29504-108.89 ..... | 4            |
| Chassisplatte .....                   | 5            |
| Gesamtschaltplan .....                | 11           |
| Bildrohrplatte 29305-122.09 .....     | 15           |
| Bildrohrplatte 29305-022.17 .....     | 17           |
| Ersatzteillisten .....                | 19           |

**Table of Contents**

|                                     | <b>Page</b> |
|-------------------------------------|-------------|
| Module List .....                   | 2           |
| Technical Data .....                | 3           |
| Videotext module 29504-108.89 ..... | 4           |
| Chassis Board .....                 | 5           |
| General Circuit Diagram .....       | 11          |
| CRT Panel 29305-122.09 .....        | 15          |
| CRT Panel 29305-022.17 .....        | 17          |
| Spare Parts Lists .....             | 19          |

**Modulübersicht / Module List**

| Gerät<br>Model   | Chassis      | Tuner        | BR-Platte<br>CRT Panel | Fernbedienung<br>Remote Control | Bedieneinheit<br>Control Units | Ton ZF<br>Audio IF | Videotext-<br>Baustein<br>Video Module | ZF-Verstärker<br>IF Amplifier |
|------------------|--------------|--------------|------------------------|---------------------------------|--------------------------------|--------------------|--|-------------------------------|
| Lissabon         | 29701-093.19 | 29504-201.31 | 29305-022.17           | 29642-059.06                    | –                              | 29504-102.40       | –                                      | –                             |
| Greenville       | 29701-093.07 | 29504-201.31 | 29305-122.08           | 29642-059.06                    | –                              | 29504-102.40       | –                                      | –                             |
| ST 55-725 FT/GB  | 29701-093.20 | 29504-201.31 | 29305-022.17           | 29642-063.01                    | –                              | 29504-162.39       | 29504-108.89                           | 29504-162.57                  |
| ST 55-750 text   | 29701-093.16 | 29504-201.31 | 29305-022.17           | 29642-059.06                    | –                              | 29504-102.40       | –                                      | –                             |
| ST 55-750/9 text | 29701-093.18 | 29504-201.31 | 29305-022.17           | 29642-059.06                    | –                              | 29504-162.39       | –                                      | 29504-162.57                  |
| ST 55-876/9 text | 29701-093.18 | 29504-201.31 | 29305-022.17           | 29642-059.06                    | –                              | 29504-162.39       | –                                      | 29504-162.57                  |
| XS 55/1          | 29701-093.17 | 29504-201.31 | 29305-122.09           | 29642-063.01                    | 29501-082.14                   | 29504-102.40       | –                                      | –                             |
| XS 55/9          | 29701-093.04 | 29504-201.31 | 29305-122.09           | 29642-063.01                    | 29501-082.14                   | 29504-162.39       | –                                      | 29504-162.57                  |

Technische Daten / Technical Data

|   | ST 55 - 750 text   | ST 55 - 750/9 text                               | ST 55 - 725 FT / GB                        | ST 55 - 876/9 text                               | XS 55/1  | XS 55/9  | Lissabon SE 5576 text                         | Greenville SP 737 text                    |
|---|--|--|--|--|--|--|---|---|
| <b>Bildröhre / Picture Tube</b>                         | 51cm   | 51cm   | 51cm                                       | 51cm   | 51cm   | 51cm   | 51cm  | 34cm                                      |
| Sichtbares Bild<br>Visible picture                      | 55cm (21")<br>Black Matrix /<br>small neck   | 55cm (21")<br>Black Matrix /<br>small neck       | 55cm (21")<br>Black Matrix /<br>small neck | 55cm (21")<br>Black Matrix /<br>small neck       | 55cm (21")<br>Black Matrix /<br>small neck       | 55cm (21")<br>Black Matrix /<br>small neck       | 55cm (21")<br>Black Matrix /<br>small neck    | 37cm (14")<br>tinted glass                |
| Ablenkwinkel<br>Deflection angle                        | 90°  | 90°  | 90°  | 90°  | 90°  | 90°  | 90°   | 90°                                       |
| Bildwechselfrequenz<br>Vertical frequency               | 50Hz   | 50Hz   | 50Hz                                       | 50Hz   | 50Hz   | 50Hz   | 50Hz  | 50Hz                                      |
| <b>Elektronik / Electronic</b>                          |  |  |  |  |  |  |   |   |
| Programmspeicherplätze<br>Programme positions           | 99 TV + 2 AV   | 99 TV + 2 AV                                     | 99 TV + 2 AV                               | 99 TV + 2 AV                                     | 99 TV + 1 AV                                     | 99 TV + 1 AV                                     | 99 TV + 2 AV                                  | 99 TV + 2 AV                              |
| AV-Auswertung<br>AV evaluation                          | auf jeden Programmplatz programmierbar / programmable for every programme position |  |  |  |  |  |   |   |
| Tuner   | Kabelluner-Raster 8MHz für Hyperband / cable tuner - 8MHz spacing for hyperband    |  |  |  |  |  |   |   |
| TV-Normen<br>TV standards                               | PAL, SECAM,<br>NTSC 4.43 MHz,<br>B/G, D/K  | PAL, SECAM,<br>NTSC, B/G, I, D/K/<br>K7D, M, L/L | PAL, I                                     | PAL, SECAM,<br>NTSC, B/G, I, D/K/<br>K7D, M, L/L | PAL, SECAM,<br>NTSC, B/G, I, D/K/<br>K7D, M, L/L | PAL, SECAM,<br>NTSC, B/G, I, D/K/<br>K7D, M, L/L | PAL, SECAM,<br>NTSC, B/G, I, D/K/<br>B/G, D/K | PAL, SECAM,<br>NTSC 4.43 MHz,<br>B/G, D/K |
| Videotext<br>Teletext                                   | 1-Seiten Text<br>1-pages text  | 1-Seiten Text<br>1-pages text                    | 4-Seiten Text<br>4-pages text              | 1-Seiten Text<br>1-pages text                    | 1-Seiten Text<br>1-pages text                    | 1-Seiten Text<br>1-pages text                    | 1-Seiten Text<br>1-pages text                 | 1-Seiten Text<br>1-pages text             |
| Musikleistung<br>Music power                            | 2x 8W  | 2x 8W  | 2x 8W                                      | 2x 8W  | 2x 8W  | 2x 8W  | 2x 8W   | 2x 8W                                     |
| <b>Anschlüsse Front / Connections front</b>             |  |  |  |  |  |  |   |   |
| Kopfhörer<br>Headphones                                 | Stereo 3.5mm Klinke / stereo 3.5mm jack  |  |  |  |  |  |   |   |
| Video IN  | 1x Cinch FBAS  | 1x Cinch FBAS                                    | 1x Cinch FBAS                              | -  | -  | -  | 1x Cinch FBAS                                 | 1x Cinch FBAS                             |
| Audio IN  | 2x Cinch Audio   | 2x Cinch Audio                                   | 2x Cinch Audio                             | -  | -  | -  | 2x Cinch Audio                                | 2x Cinch Audio                            |
| S-Video   | -  | -  | -  | -  | -  | -  | -   | -   |
| <b>Anschlüsse Rückwand / Connections rear panel</b>     |  |  |  |  |  |  |   |   |
| Euro AV (schwarz/black)                                 | voll belegt<br>fully wired   | voll belegt<br>fully wired                       | voll belegt<br>fully wired                 | voll belegt<br>fully wired                       | voll belegt<br>fully wired                       | voll belegt<br>fully wired                       | voll belegt<br>fully wired                    | voll belegt<br>fully wired                |
| <b>Netzteil / Mains Stage</b>                           |  |  |  |  |  |  |   |   |
| Netzspannung (Regelbereich)<br>Mains voltage (variable) | 165 ... 265V   | 165 ... 265V                                     | 165 ... 265V                               | 165 ... 265V                                     | 165 ... 265V                                     | 165 ... 265V                                     | 165 ... 265V                                  | 165 ... 265V                              |
| Netzfrequenz<br>Mains frequency                         | 50 / 60Hz  | 50 / 60Hz  | 50 / 60Hz                                  | 50 / 60Hz  | 50 / 60Hz  | 50 / 60Hz  | 50 / 60Hz                                     | 50 / 60Hz                                 |
| Leistungsaufnahme<br>Power consumption                  | ca. 55W  | ca. 55W  | ca. 55W                                    | ca. 55W  | ca. 55W  | ca. 55W  | ca. 60W                                       | ca. 45W                                   |
| Standby   | ca. 6W   | ca. 6W   | ca. 6W                                     | ca. 6W   | ca. 6W   | ca. 6W   | ca. 9W  | ca. 6W                                    |

Platinenabbildungen und Schaltpläne / Layout of the PCBs and Circuit Diagrams

Videotext 29504-108.89

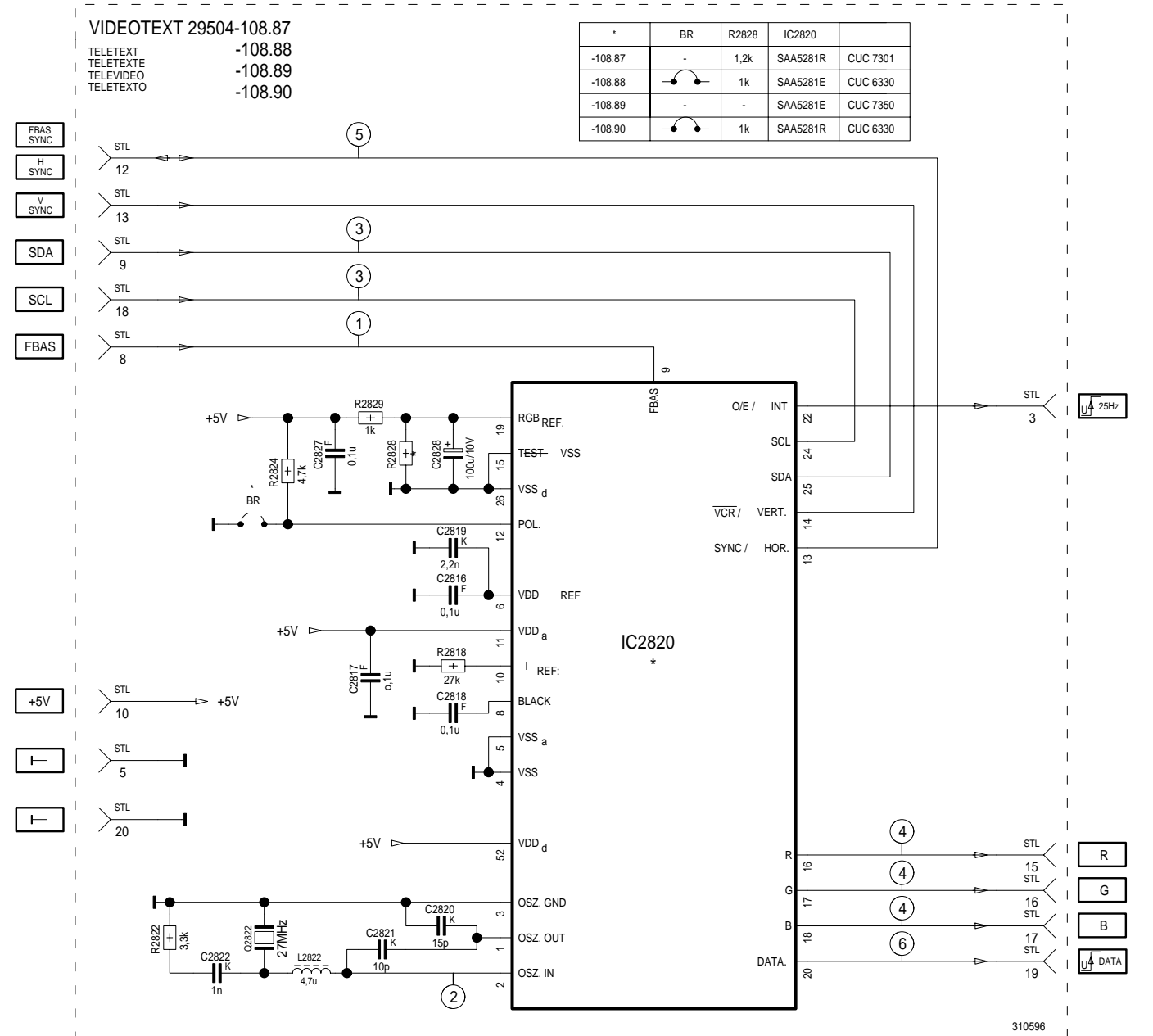

|         | BR | R2828 | IC2820   |          |
|---------|----|-------|----------|----------|
| -108.87 | -  | 1,2k  | SAA5281R | CUC 7301 |
| -108.88 | -  | 1k    | SAA5281E | CUC 6330 |
| -108.89 | -  | -     | SAA5281E | CUC 7350 |
| -108.90 | -  | 1k    | SAA5281R | CUC 6330 |

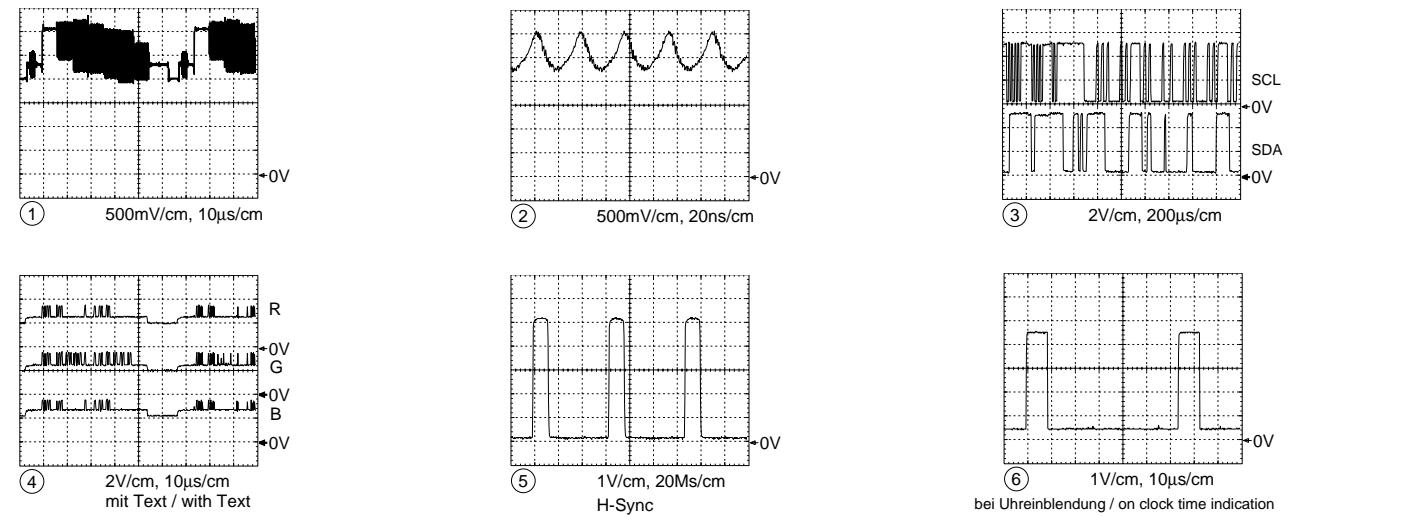

### Chassisplatte / Chassis Board

Bestückungsseite, Ansicht von oben  
Component side, top view

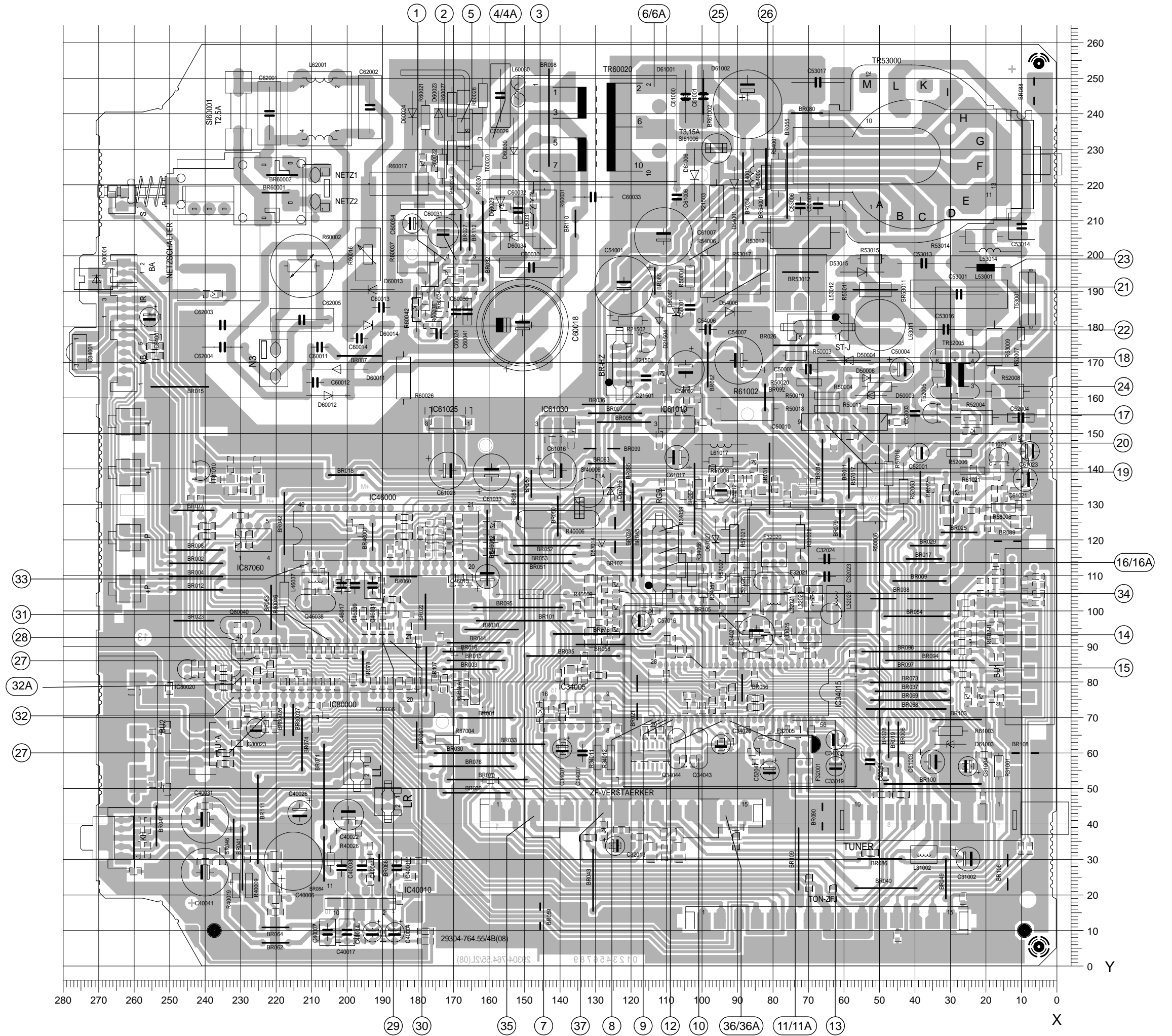

**Chassisplatte****Koordinaten für die Bauteile der Bestückungsseite (Oberseite)**

| Pos.-Nr./<br>Pos. No. | Koordinaten/<br>Coordinates |     | Pos.-Nr./<br>Pos. No. | Koordinaten/<br>Coordinates |     | Pos.-Nr./<br>Pos. No. | Koordinaten/<br>Coordinates |     | Pos.-Nr./<br>Pos. No. | Koordinaten/<br>Coordinates |     | Pos.-Nr./<br>Pos. No. | Koordinaten/<br>Coordinates |     |           |     |     |
|-----------------------|-----------------------------|-----|-----------------------|-----------------------------|-----|-----------------------|-----------------------------|-----|-----------------------|-----------------------------|-----|-----------------------|-----------------------------|-----|-----------|-----|-----|
|                       | X                           | Y   |                       | X                           | Y   |                       | X                           | Y   |                       | X                           | Y   |                       | X                           | Y   | X         | Y   |     |
| AN10                  | 5                           | 255 | C50004                | 44                          | 169 | C61028                | 173                         | 140 | IC60030               | 169                         | 195 | R34012                | 126                         | 59  | R60027    | 171 | 244 |
| AN11                  | 5                           | 5   | C50007                | 70                          | 169 | C61033                | 160                         | 139 | IC61010               | 108                         | 153 | R34057                | 100                         | 108 | R60028    | 163 | 246 |
| AN12                  | 5                           | 161 | C52001                | 39                          | 145 | C62001                | 223                         | 241 | IC61025               | 173                         | 153 | R34058                | 103                         | 111 | R60030    | 158 | 215 |
| AN13                  | 5                           | 5   | C52003                | 40                          | 156 | C62002                | 194                         | 243 | IC61030               | 141                         | 153 | R34059                | 106                         | 113 | R60031    | 145 | 211 |
| AN20                  | 5                           | 256 | C52004                | 10                          | 155 | C62003                | 236                         | 181 | IC80000               | 208                         | 84  | R40006                | 141                         | 126 | R60034    | 176 | 196 |
| AN30                  | 239                         | 10  | C52047                | 81                          | 55  | C62004                | 236                         | 175 | IC80020               | 247                         | 84  | R40009                | 229                         | 23  | R60036    | 179 | 189 |
| AN31                  | 9                           | 10  | C52054                | 53                          | 58  | C62005                | 214                         | 183 | IC84001               | 278                         | 174 | R40019                | 233                         | 23  | R60037    | 183 | 201 |
| AU01A                 | 242                         | 63  | C53001                | 28                          | 190 | C80006                | 181                         | 73  | IC87060               | 228                         | 120 | R40026                | 206                         | 30  | R60042    | 181 | 186 |
| BA                    | 264                         | 197 | C53006                | 73                          | 215 | C80023                | 227                         | 67  | IR                    | 264                         | 186 | R46009                | 149                         | 105 | R61002    | 88  | 158 |
| BR-HZ                 | 124                         | 170 | C53007                | 68                          | 215 | C84001                | 257                         | 184 | KB                    | 264                         | 171 | R50001                | 104                         | 195 | R61003    | 30  | 66  |
| BR-HZ01               | 124                         | 170 | C53013                | 38                          | 199 | D21504                | 113                         | 183 | KH                    | 269                         | 36  | R50003                | 74                          | 172 | R61021    | 24  | 140 |
| BU01                  | 6                           | 93  | C53014                | 10                          | 209 | D50001                | 108                         | 185 | KH01                  | 265                         | 36  | R50004                | 50                          | 164 | R80046    | 219 | 105 |
| BU02                  | 268                         | 66  | C53016                | 31                          | 180 | D50003                | 53                          | 161 | L31002                | 38                          | 31  | R50006                | 51                          | 134 | R87004    | 173 | 64  |
| C21501                | 116                         | 166 | C53017                | 68                          | 250 | D50004                | 59                          | 171 | L32021                | 80                          | 103 | R50011                | 50                          | 158 | RGB       | 112 | 115 |
| C31002                | 25                          | 30  | C54001                | 123                         | 192 | D50006                | 54                          | 166 | L32023                | 69                          | 104 | R50018                | 65                          | 158 | RGB01     | 112 | 115 |
| C31004                | 25                          | 56  | C54006                | 99                          | 180 | D53015                | 55                          | 196 | L32026                | 63                          | 104 | R50019                | 65                          | 161 | RGB02-A   | 165 | 78  |
| C32013                | 125                         | 34  | C54007                | 89                          | 171 | D54001                | 91                          | 221 | L46037                | 210                         | 109 | R50020                | 70                          | 165 | RGB02-B   | 21  | 94  |
| C32023                | 65                          | 110 | C57012                | 95                          | 134 | D54006                | 93                          | 185 | L53001                | 20                          | 198 | R52004                | 23                          | 155 | S         | 265 | 217 |
| C32024                | 65                          | 115 | C57016                | 117                         | 97  | D57013                | 126                         | 134 | L53011                | 50                          | 181 | R52006                | 28                          | 145 | SI40006   | 133 | 134 |
| C33019                | 63                          | 56  | C60011                | 209                         | 175 | D57014                | 129                         | 119 | L53012                | 72                          | 193 | R52007                | 10                          | 179 | SI60001   | 232 | 242 |
| C34001                | 140                         | 61  | C60012                | 210                         | 165 | D57027                | 97                          | 121 | L53014                | 19                          | 202 | R52008                | 14                          | 162 | SI61006   | 96  | 231 |
| C34007                | 134                         | 60  | C60013                | 191                         | 186 | D60011                | 204                         | 169 | L54001                | 86                          | 223 | R52063                | 43                          | 134 | ST-J      | 68  | 181 |
| C34021                | 85                          | 93  | C60014                | 198                         | 178 | D60012                | 206                         | 161 | L60030                | 152                         | 248 | R53009                | 18                          | 175 | ST-J01    | 68  | 181 |
| C34026                | 95                          | 63  | C60018                | 152                         | 181 | D60013                | 194                         | 191 | L60031                | 148                         | 216 | R53011                | 51                          | 191 | ST-NETZ   | 209 | 220 |
| C34033                | 63                          | 64  | C60018A               | 151                         | 180 | D60014                | 195                         | 181 | L61017                | 95                          | 147 | R53012                | 73                          | 208 | T21501    | 116 | 176 |
| C40001                | 187                         | 28  | C60024                | 170                         | 185 | D60023                | 175                         | 241 | L62001                | 209                         | 242 | R53015                | 21                          | 206 | T52005    | 36  | 156 |
| C40004                | 188                         | 9   | C60029                | 158                         | 246 | D60024                | 183                         | 241 | LL                    | 198                         | 55  | R53017                | 53                          | 200 | T53001    | 8   | 189 |
| C40006                | 216                         | 29  | C60030                | 149                         | 198 | D60034                | 154                         | 206 | LL01                  | 198                         | 55  | R54001                | 79                          | 224 | T60020    | 172 | 234 |
| C40007                | 206                         | 9   | C60031                | 174                         | 208 | D60034                | 154                         | 206 | LR                    | 189                         | 46  | R54002                | 82                          | 223 | T61020    | 16  | 144 |
| C40008                | 203                         | 28  | C60032                | 152                         | 214 | D61001                | 105                         | 246 | LR01                  | 189                         | 46  | R54006                | 99                          | 195 | T81010    | 242 | 140 |
| C40011                | 197                         | 28  | C60033                | 131                         | 217 | D61002                | 100                         | 246 | N03                   | 222                         | 170 | R57006                | 95                          | 143 | TON-ZF    | 65  | 11  |
| C40014                | 194                         | 9   | C60034                | 183                         | 210 | D61003                | 30                          | 63  | NETZ01                | 207                         | 225 | R57016                | 48                          | 139 | TR52005   | 29  | 168 |
| C40017                | 201                         | 9   | C60041                | 167                         | 185 | D61006                | 102                         | 224 | NETZ02                | 207                         | 215 | R57017                | 55                          | 139 | TR53000   | 36  | 230 |
| C40022                | 201                         | 42  | C60047                | 175                         | 179 | D80001                | 272                         | 194 | NETZSCH.              | 242                         | 209 | R57021                | 91                          | 121 | TR53000A  | 37  | 227 |
| C40026                | 214                         | 43  | C61000                | 105                         | 246 | F32001                | 73                          | 55  | Q34043                | 101                         | 61  | R57026                | 91                          | 108 | TR60020   | 130 | 237 |
| C40031                | 241                         | 41  | C61001                | 100                         | 246 | F32005                | 76                          | 63  | Q34044                | 108                         | 61  | R57027                | 94                          | 120 | TUNER     | 29  | 42  |
| C40041                | 241                         | 26  | C61002                | 88                          | 244 | F32020                | 80                          | 116 | Q46038                | 210                         | 103 | R58008                | 15                          | 129 | X01       | 0   | 275 |
| C46013                | 161                         | 110 | C61003                | 35                          | 58  | F33025                | 70                          | 95  | Q80040                | 231                         | 96  | R60002                | 214                         | 198 | X02       | 16  | 0   |
| C46017                | 203                         | 108 | C61006                | 108                         | 217 | IC34005               | 136                         | 72  | R60016                | 195                         | 201 | R60002                | 214                         | 198 | X03       | 0   | 5   |
| C46031                | 194                         | 108 | C61007                | 111                         | 206 | IC34015               | 90                          | 77  | R60017                | 186                         | 221 | R60024                | 171                         | 230 | X04       | 305 | 0   |
| C46039                | 199                         | 108 | C61016                | 142                         | 140 | IC40010               | 197                         | 19  | R60022                | 179                         | 240 | R60026                | 185                         | 166 | ZF-VERST. | 123 | 42  |
| C50001                | 104                         | 186 | C61017                | 107                         | 144 | IC46000               | 190                         | 122 | R60026                | 174                         | 226 |                       |                             |     |           |     |     |
| C50002                | 105                         | 169 | C61021                | 9                           | 138 | IC50010               | 60                          | 154 |                       |                             |     |                       |                             |     |           |     |     |
|                       |                             |     | C61023                | 8                           | 146 |                       |                             |     |                       |                             |     |                       |                             |     |           |     |     |

**Chassis Board****Coordinates of the components on the components side (top side)**

## Chassisplatte

Koordinaten für die Bauteile der Lötseite (Unterseite)

| Pos.-Nr./<br>Pos. No. | Koordinaten/<br>Coordinates |     | Pos.-Nr./<br>Pos. No. | Koordinaten/<br>Coordinates |     | Pos.-Nr./<br>Pos. No. | Koordinaten/<br>Coordinates |     | Pos.-Nr./<br>Pos. No. | Koordinaten/<br>Coordinates |     | Pos.-Nr./<br>Pos. No. | Koordinaten/<br>Coordinates |     |         |     |     |
|-----------------------|-----------------------------|-----|-----------------------|-----------------------------|-----|-----------------------|-----------------------------|-----|-----------------------|-----------------------------|-----|-----------------------|-----------------------------|-----|---------|-----|-----|
|                       | X                           | Y   |                       | X                           | Y   |                       | X                           | Y   |                       | X                           | Y   |                       | X                           | Y   | X       | Y   |     |
| CBR01                 | 256                         | 172 | CC40009               | 229                         | 32  | CC80048               | 224                         | 89  | CR32029               | 82                          | 96  | CR46012               | 172                         | 126 | CR80023 | 229 | 72  |
| CBR02                 | 70                          | 23  | CC40012               | 194                         | 28  | CC80051               | 175                         | 92  | CR33014               | 75                          | 89  | CR46014               | 169                         | 109 | CR80026 | 219 | 79  |
| CBR03                 | 140                         | 72  | CC40013               | 194                         | 24  | CC80053               | 197                         | 100 | CR33025               | 70                          | 91  | CR46016               | 189                         | 117 | CR80027 | 217 | 79  |
| CBR05                 | 85                          | 73  | CC40019               | 236                         | 31  | CC84002               | 214                         | 83  | CR34001               | 141                         | 82  | CR46021               | 128                         | 93  | CR80031 | 161 | 72  |
| CBR06                 | 91                          | 35  | CC40032               | 261                         | 27  | CC87001               | 199                         | 81  | CR34003               | 134                         | 82  | CR46022               | 129                         | 97  | CR80032 | 160 | 52  |
| CBR07                 | 92                          | 77  | CC40033               | 260                         | 39  | CC87002               | 224                         | 68  | CR34007               | 143                         | 72  | CR46026               | 128                         | 101 | CR80036 | 207 | 72  |
| CBR09                 | 44                          | 48  | CC40043               | 260                         | 33  | CC87003               | 222                         | 68  | CR34023               | 86                          | 81  | CR46033               | 186                         | 118 | CR80037 | 206 | 79  |
| CBR10                 | 130                         | 82  | CC43010               | 5                           | 108 | CC87007               | 210                         | 68  | CR34027               | 100                         | 73  | CR46038               | 212                         | 106 | CR80039 | 184 | 99  |
| CBR11                 | 85                          | 76  | CC43011               | 5                           | 105 | CC87011               | 170                         | 89  | CR34042               | 105                         | 73  | CR46039               | 191                         | 108 | CR80042 | 231 | 96  |
| CBR12                 | 235                         | 57  | CC43013               | 9                           | 108 | CC87012               | 191                         | 100 | CR34056               | 94                          | 97  | CR46041               | 128                         | 108 | CR80046 | 210 | 73  |
| CBR13                 | 98                          | 73  | CC43014               | 9                           | 104 | CC87013               | 194                         | 100 | CR40001               | 181                         | 30  | CR46042               | 110                         | 82  | CR80047 | 236 | 84  |
| CBR14                 | 241                         | 121 | CC43016               | 25                          | 103 | CC87014               | 219                         | 89  | CR40002               | 185                         | 29  | CR47002               | 185                         | 124 | CR80048 | 222 | 89  |
| CBR16                 | 226                         | 82  | CC43017               | 58                          | 83  | CC87061               | 232                         | 120 | CR40003               | 185                         | 9   | CR47003               | 200                         | 125 | CR80050 | 204 | 79  |
| CBR17                 | 185                         | 121 | CC43021               | 27                          | 89  | CD21503               | 112                         | 168 | CR40004               | 191                         | 8   | CR50016               | 23                          | 139 | CR80051 | 206 | 89  |
| CBR18                 | 133                         | 36  | CC43026               | 27                          | 91  | CD32011               | 128                         | 38  | CR40005               | 179                         | 7   | CR50017               | 25                          | 134 | CR80052 | 193 | 95  |
| CBR19                 | 63                          | 20  | CC43027               | 27                          | 94  | CD34007               | 146                         | 72  | CR40005               | 179                         | 7   | CR50023               | 35                          | 136 | CR80053 | 196 | 95  |
| CBR20                 | 236                         | 81  | CC43028               | 27                          | 96  | CD43017               | 21                          | 76  | CR40007               | 210                         | 9   | CR52001               | 9                           | 141 | CR80054 | 199 | 100 |
| CBR21                 | 241                         | 124 | CC43030               | 16                          | 105 | CD43021               | 25                          | 76  | CR40011               | 198                         | 39  | CR52047               | 84                          | 58  | CR80056 | 231 | 127 |
| CBR22                 | 256                         | 175 | CC43031               | 17                          | 114 | CD46006               | 160                         | 125 | CR40012               | 194                         | 33  | CR52051               | 94                          | 73  | CR80057 | 229 | 79  |
| CBR23                 | 223                         | 84  | CC43032               | 45                          | 8   | CD46007               | 160                         | 121 | CR40013               | 198                         | 10  | CR52052               | 73                          | 66  | CR81001 | 242 | 131 |
| CBR24                 | 236                         | 79  | CC44001               | 252                         | 50  | CD46008               | 160                         | 117 | CR40014               | 198                         | 7   | CR57002               | 76                          | 132 | CR81002 | 226 | 142 |
| CBR25                 | 235                         | 60  | CC44002               | 252                         | 67  | CD46021               | 125                         | 95  | CR40017               | 203                         | 8   | CR57003               | 80                          | 136 | CR81003 | 230 | 136 |
| CBR26                 | 31                          | 134 | CC44008               | 251                         | 78  | CD46026               | 125                         | 101 | CR40022               | 221                         | 15  | CR57004               | 87                          | 132 | CR81006 | 234 | 142 |
| CBR27                 | 53                          | 32  | CC46014               | 171                         | 109 | CD46041               | 125                         | 108 | CR40031               | 241                         | 45  | CR57008               | 87                          | 137 | CR81007 | 239 | 137 |
| CBR30                 | 48                          | 54  | CC46018               | 201                         | 108 | CD50011               | 115                         | 100 | CR40032               | 258                         | 39  | CR57011               | 92                          | 137 | CR83001 | 199 | 89  |
| CBR31                 | 185                         | 127 | CC46019               | 204                         | 108 | CD50016               | 28                          | 134 | CR40041               | 241                         | 29  | CR57012               | 90                          | 137 | CR83002 | 201 | 89  |
| CBR32                 | 188                         | 103 | CC46036               | 209                         | 111 | CD52001               | 24                          | 151 | CR40042               | 258                         | 33  | CR57013               | 123                         | 132 | CR83003 | 204 | 89  |
| CBR33                 | 98                          | 139 | CC46037               | 210                         | 116 | CD57011               | 86                          | 142 | CR43010               | 8                           | 33  | CR57014               | 92                          | 133 | CR83004 | 209 | 89  |
| CBR34                 | 229                         | 120 | CC46038               | 208                         | 106 | CD60022               | 180                         | 227 | CR43011               | 5                           | 110 | CR57015               | 109                         | 93  | CR84001 | 256 | 184 |
| CC31002               | 49                          | 48  | CC47001               | 183                         | 117 | CD60031               | 157                         | 215 | CR43012               | 5                           | 103 | CR57016               | 107                         | 89  | CR84002 | 255 | 178 |
| CC32005               | 80                          | 64  | CC47002               | 197                         | 123 | CD60034               | 170                         | 194 | CR43013               | 10                          | 33  | CR57017               | 104                         | 89  | CR84003 | 214 | 79  |
| CC32011               | 111                         | 37  | CC50003               | 63                          | 148 | CD60046               | 182                         | 186 | CR43014               | 25                          | 100 | CR57020               | 94                          | 103 | CR87001 | 226 | 89  |
| CC32025               | 68                          | 104 | CC50006               | 58                          | 150 | CD60047               | 177                         | 181 | CR43016               | 27                          | 82  | CR57022               | 87                          | 108 | CR87002 | 224 | 72  |
| CC32026               | 27                          | 19  | CC50011               | 45                          | 154 | CD61013               | 105                         | 157 | CR43017               | 16                          | 75  | CR57023               | 87                          | 113 | CR87003 | 222 | 72  |
| CC33014               | 76                          | 94  | CC50013               | 72                          | 136 | CD61023               | 10                          | 150 | CR43018               | 16                          | 82  | CR58000               | 18                          | 134 | CR87012 | 191 | 95  |
| CC33016               | 71                          | 88  | CC50019               | 78                          | 165 | CD80017               | 169                         | 77  | CR43021               | 58                          | 88  | CR58002               | 20                          | 125 | CR87013 | 189 | 95  |
| CC33017               | 86                          | 88  | CC52001               | 29                          | 160 | CD80018               | 169                         | 79  | CR43023               | 18                          | 76  | CR58003               | 15                          | 134 | CR87015 | 212 | 89  |
| CC33018               | 69                          | 66  | CC52002               | 24                          | 155 | CD80019               | 169                         | 82  | CR43026               | 18                          | 86  | CR58005               | 123                         | 136 | CT32014 | 115 | 32  |
| CC33025               | 70                          | 95  | CC52046               | 86                          | 60  | CD81083               | 239                         | 190 | CR43027               | 16                          | 92  | CR58006               | 90                          | 133 | CT32015 | 107 | 32  |
| CC33027               | 91                          | 93  | CC52048               | 89                          | 67  | CIC34010              | 115                         | 59  | CR43028               | 18                          | 99  | CR58007               | 98                          | 134 | CT32020 | 80  | 89  |
| CC33028               | 98                          | 81  | CC57003               | 77                          | 66  | CR21504               | 109                         | 186 | CR43030               | 16                          | 95  | CR58008               | 112                         | 136 | CT32025 | 73  | 102 |
| CC34002               | 140                         | 61  | CC57016               | 84                          | 66  | CR31003               | 21                          | 47  | CR43031               | 16                          | 86  | CR58009               | 24                          | 129 | CT34001 | 138 | 82  |
| CC34003               | 134                         | 87  | CC57023               | 87                          | 111 | CR31004               | 25                          | 56  | CR43033               | 16                          | 99  | CR60022               | 176                         | 227 | CT40025 | 222 | 20  |
| CC34006               | 130                         | 71  | CC58002               | 16                          | 125 | CR31006               | 20                          | 60  | CR43036               | 16                          | 111 | CR60031               | 148                         | 217 | CT40030 | 222 | 29  |
| CC34007               | 137                         | 72  | CC58006               | 101                         | 130 | CR32011               | 108                         | 37  | CR43037               | 21                          | 109 | CR60039               | 175                         | 187 | CT46006 | 171 | 117 |
| CC34008               | 115                         | 66  | CC60039               | 175                         | 184 | CR32012               | 118                         | 36  | CR43038               | 16                          | 109 | CR60046               | 179                         | 189 | CT46007 | 171 | 121 |
| CC34009               | 112                         | 66  | CC60043               | 170                         | 196 | CR32013               | 123                         | 38  | CR44001               | 255                         | 51  | CR61012               | 100                         | 154 | CT46008 | 171 | 126 |
| CC34011               | 125                         | 51  | CC61011               | 113                         | 149 | CR32014               | 125                         | 34  | CR44002               | 255                         | 66  | CR61013               | 102                         | 162 | CT46020 | 132 | 93  |
| CC34012               | 124                         | 66  | CC61012               | 105                         | 162 | CR32016               | 111                         | 32  | CR44007               | 261                         | 77  | CR61022               | 17                          | 139 | CT46025 | 132 | 101 |
| CC34022               | 85                          | 94  | CC61014               | 110                         | 159 | CR32018               | 84                          | 100 | CR44008               | 231                         | 63  | CR80002               | 245                         | 131 | CT46040 | 132 | 108 |
| CC34023               | 94                          | 77  | CC61026               | 167                         | 155 | CR32019               | 89                          | 96  | CR46001               | 176                         | 116 | CR80007               | 209                         | 79  | CT50020 | 31  | 127 |
| CC34027               | 95                          | 63  | CC61027               | 178                         | 155 | CR32020               | 88                          | 93  | CR46002               | 176                         | 121 | CR80008               | 212                         | 79  | CT57005 | 84  | 136 |
| CC34036               | 117                         | 66  | CC61031               | 138                         | 149 | CR32021               | 83                          | 111 | CR46003               | 176                         | 125 | CR80011               | 189                         | 80  | CT57016 | 111 | 89  |
| CC34038               | 110                         | 66  | CC61032               | 142                         | 149 | CR32022               | 76                          | 106 | CR46004               | 166                         | 109 | CR80012               | 191                         | 80  | CT57020 | 91  | 108 |
| CC34039               | 94                          | 89  | CC80011               | 186                         | 80  | CR32023               | 72                          | 106 | CR46006               | 176                         | 119 | CR80013               | 193                         | 80  | CT57025 | 96  | 109 |
| CC34041               | 103                         | 73  | CC80012               | 183                         | 80  | CR32024               | 82                          | 93  | CR46007               | 176                         | 123 | CR80014               | 181                         | 92  | CT58005 | 10  | 126 |
| CC34042               | 104                         | 76  | CC80013               | 176                         | 80  | CR32025               | 73                          | 110 | CR46008               | 180                         | 122 | CR80016               | 183                         | 95  | CT58006 | 101 | 135 |
| CC34043               | 103                         | 58  | CC80016               | 136                         | 101 | CR32026               | 91                          | 39  | CR46010               | 172                         | 117 | CR80017               | 169                         | 74  | CT58010 | 10  | 134 |
| CC34044               | 106                         | 58  | CC80021               | 242                         | 84  | CR32027               | 79                          | 95  | CR46011               | 172                         | 121 | CR80018               | 181                         | 80  | CT80023 | 233 | 70  |
| CC40002               | 183                         | 25  | CC80042               | 229                         | 89  |                       |                             |     |                       |                             |     | CR80019               | 174                         | 80  | CT81000 | 226 | 136 |
| CC40003               | 186                         | 19  | CC80043               | 231                         | 89  |                       |                             |     |                       |                             |     | CR80022               | 232                         | 79  | CT81005 | 234 | 136 |

## Chassis Board

Coordinates of the components on the solder side (bottom side)

| Pos.-Nr./<br>Pos. No. | Koordinaten/<br>Coordinates |     | Pos.-Nr./<br>Pos. No. | Koordinaten/<br>Coordinates |     | Pos.-Nr./<br>Pos. No. | Koordinaten/<br>Coordinates |     | Pos.-Nr./<br>Pos. No. | Koordinaten/<br>Coordinates |    | Pos.-Nr./<br>Pos. No. | Koordinaten/<br>Coordinates |     |         |     |    |
|-----------------------|-----------------------------|-----|-----------------------|-----------------------------|-----|-----------------------|-----------------------------|-----|-----------------------|-----------------------------|----|-----------------------|-----------------------------|-----|---------|-----|----|
|                       | X                           | Y   |                       | X                           | Y   |                       | X                           | Y   |                       | X                           | Y  |                       | X                           | Y   | X       | Y   |    |
| CBR01                 | 256                         | 172 | CC40009               | 229                         | 32  | CC80048               | 224                         | 89  | CR32029               | 82                          | 96 | CR46012               | 172                         | 126 | CR80023 | 229 | 72 |
| CBR02                 | 70                          | 23  | CC40012               | 194                         | 28  | CC80051               | 175                         | 92  | CR33014               | 75                          | 89 | CR46014               | 169                         | 109 | CR80026 | 219 | 79 |
| CBR03                 | 140                         | 72  | CC40013               | 194                         | 24  | CC80053               | 197                         | 100 | CR33025               | 70                          | 91 | CR46016               | 189                         | 117 | CR80027 | 217 | 79 |
| CBR05                 | 85                          | 73  | CC40019               | 236                         | 31  | CC84002               | 214                         | 83  | CR34001               | 141                         | 82 | CR46021               | 128                         | 93  | CR80031 | 161 | 72 |
| CBR06                 | 91                          | 35  | CC40032               | 261                         | 27  | CC87001               | 199                         | 81  | CR34003               | 134                         | 82 | CR46022               | 129                         | 97  | CR80032 | 160 | 52 |
| CBR07                 | 92                          | 77  | CC40033               | 260                         | 39  | CC87002               | 224                         | 68  | CR34007               | 143                         | 72 | CR46026               | 128                         | 101 | CR80036 | 207 | 72 |
| CBR09                 | 44                          | 48  | CC40043               | 260                         | 33  | CC87003               | 222                         | 68  | CR34023               | 86                          | 81 | CR46033               | 186                         | 118 | CR80037 | 206 | 79 |
| CBR10                 | 130                         | 82  | CC43010               | 5                           | 108 | CC87007               | 210                         | 68  | CR34027               | 100                         | 73 | CR46038               | 212                         | 106 | CR80039 | 184 | 99 |
| CBR11                 | 85                          | 76  | CC43011               | 5                           | 105 | CC87011               | 170                         | 89  | CR34042               | 105                         | 73 | CR46039               | 191                         | 108 | CR80042 | 231 | 96 |
| CBR12                 | 235                         | 57  | CC43013               | 9                           | 108 | CC87012               | 191                         | 100 | CR34056               | 94                          | 97 | CR46041               | 128                         | 108 | CR80046 | 210 | 73 |
| CBR13                 | 98                          | 73  | CC43014               | 9                           | 104 | CC87013               | 194                         | 100 | CR40001               | 181                         | 30 | CR46042               | 110                         | 82  | CR80047 | 236 | 84 |
| CBR14                 | 241                         | 121 | CC43016               | 25                          | 103 | CC                    |                             |     |                       |                             |    |                       |                             |     |         |     |    |

### Chassisplatte / Chassis Board

Lötseite, Ansicht von unten  
Solder side, bottom view

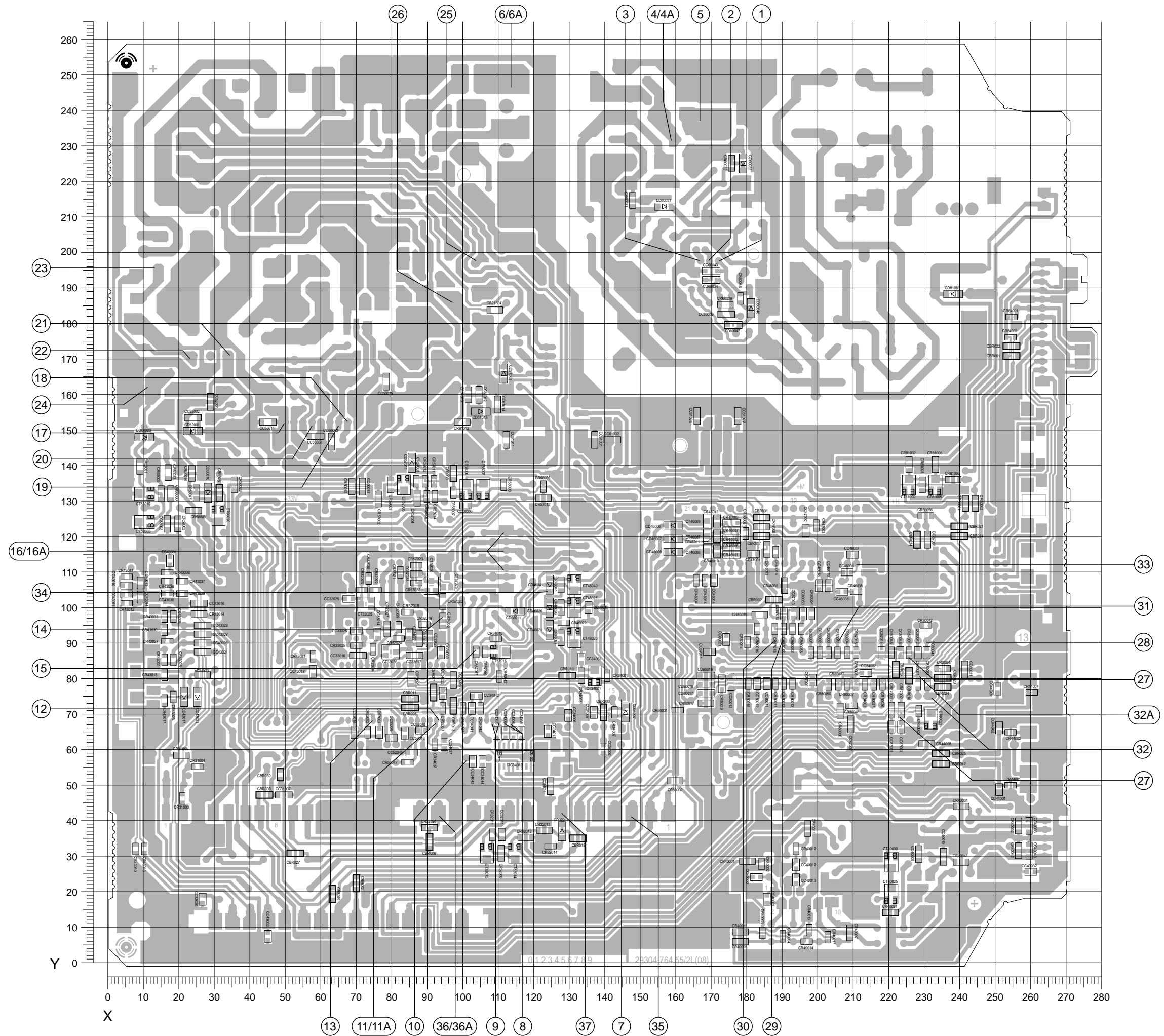

Gesamtschaltplan / General Circuit Diagram

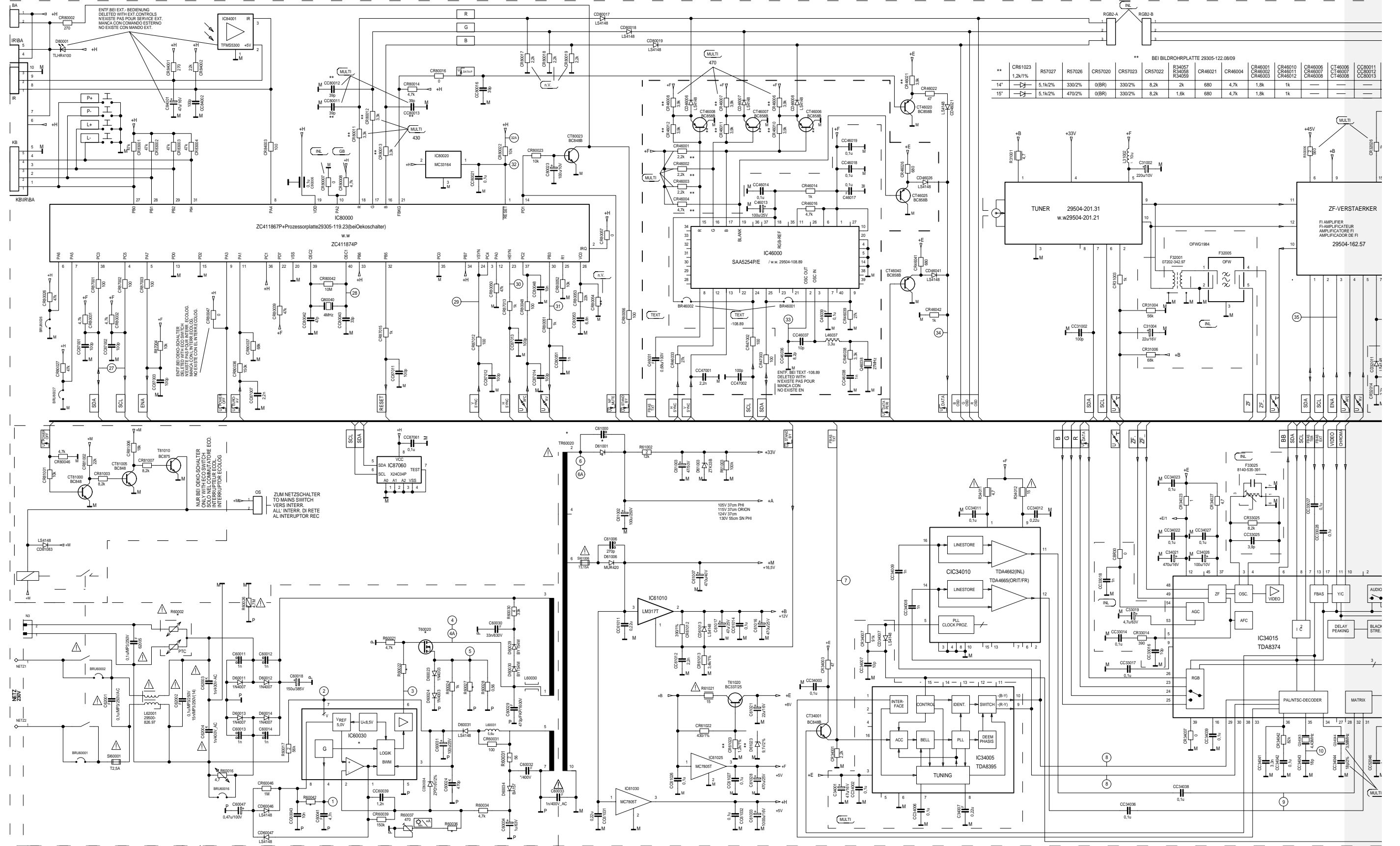



# Gesamtschaltplan / General Circuit Diagram

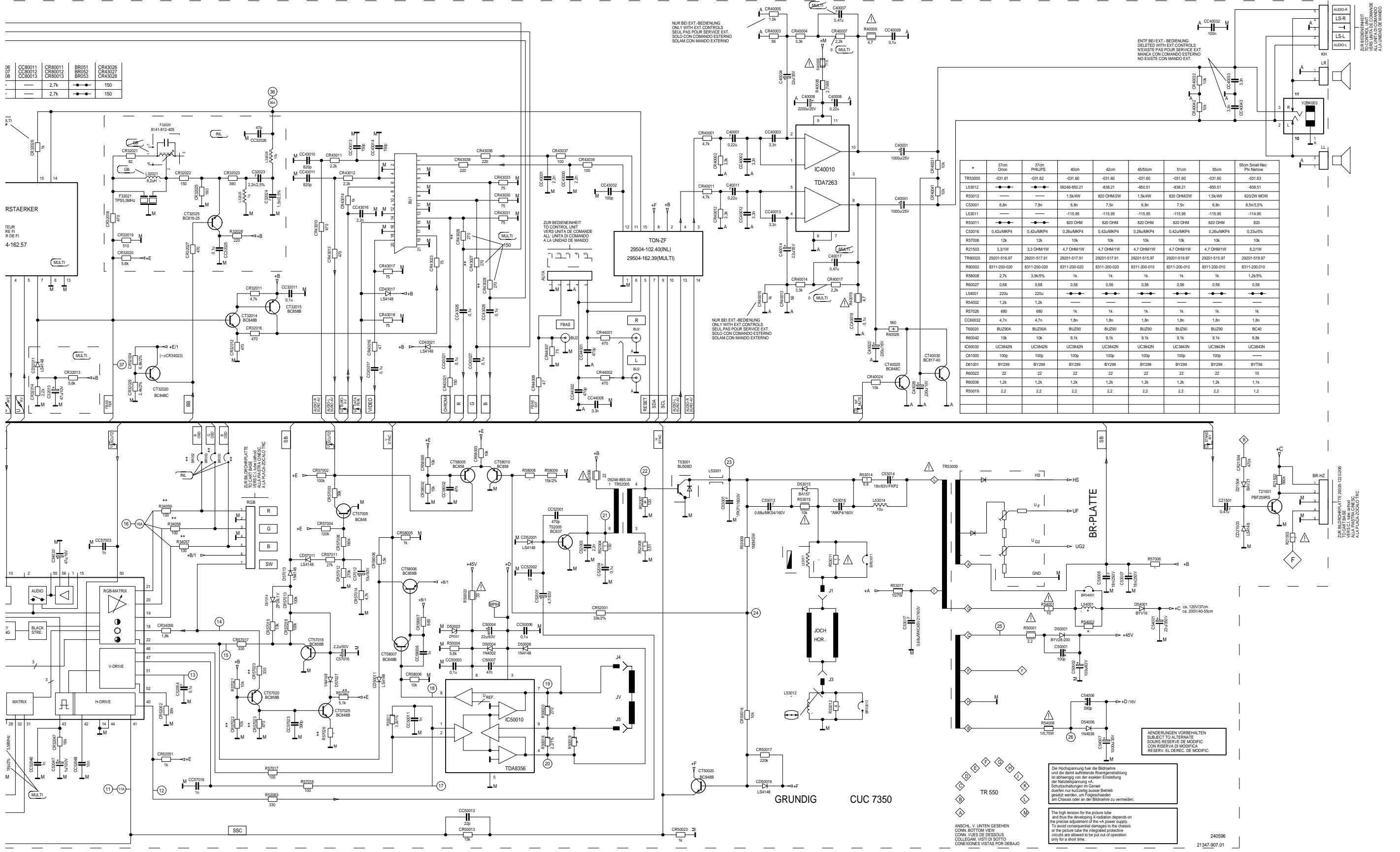

**Bildrohrplatte / CRT Panel 29305-122.09**

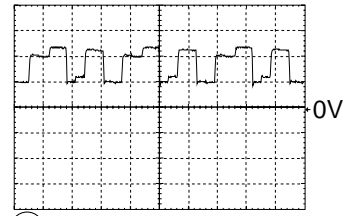

④ 50V/cm, 20µs/cm

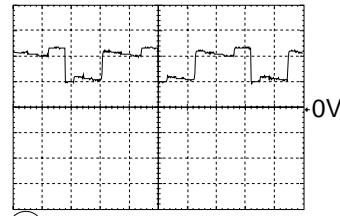

⑤ 50V/cm, 20µs/cm

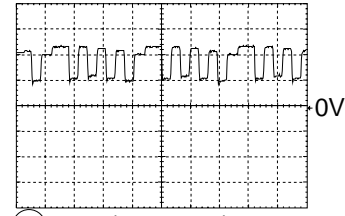

⑥ 50V/cm, 20µs/cm

**Bestückungsseite, Ansicht von oben**  
**Component side, top view**

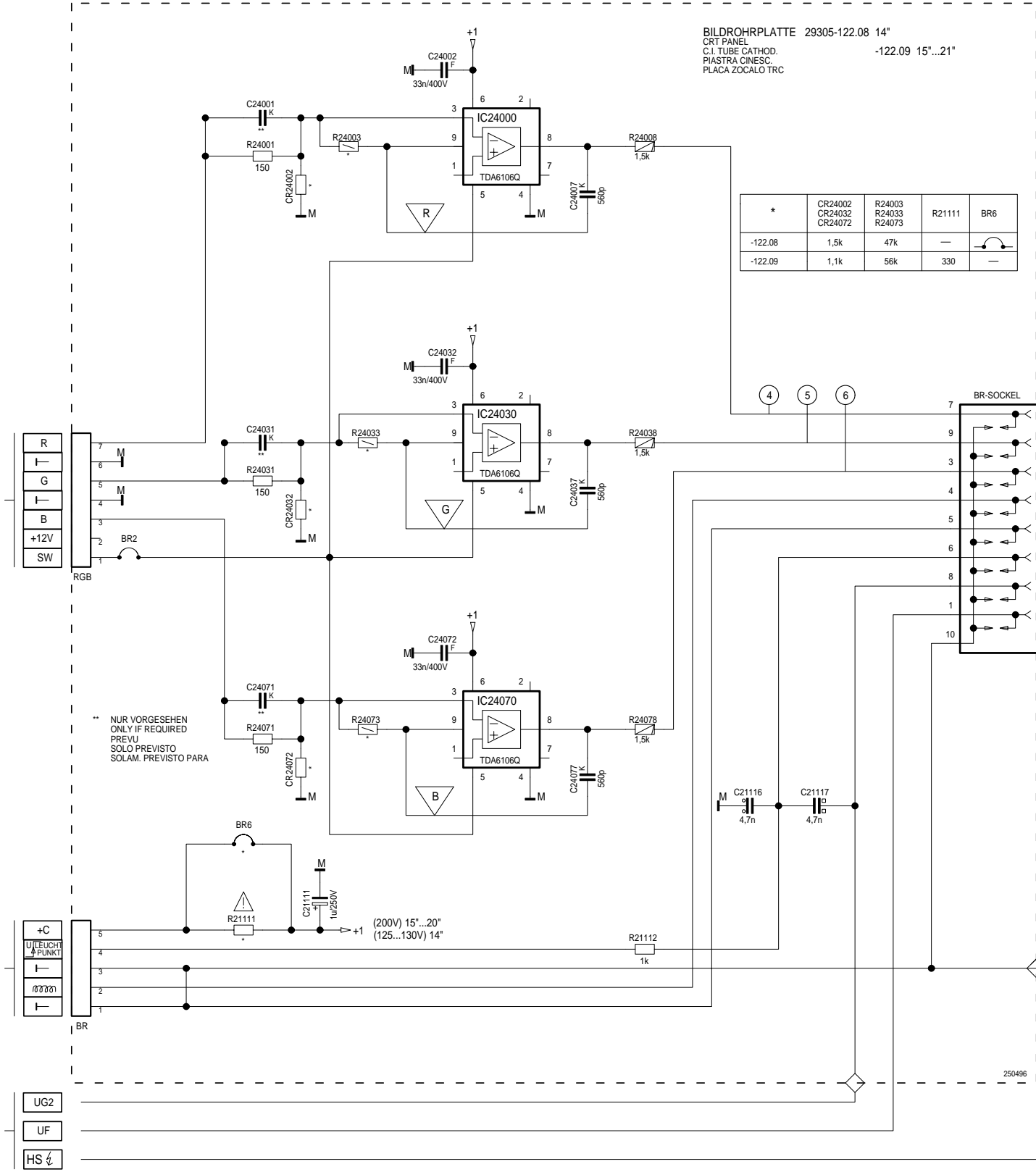
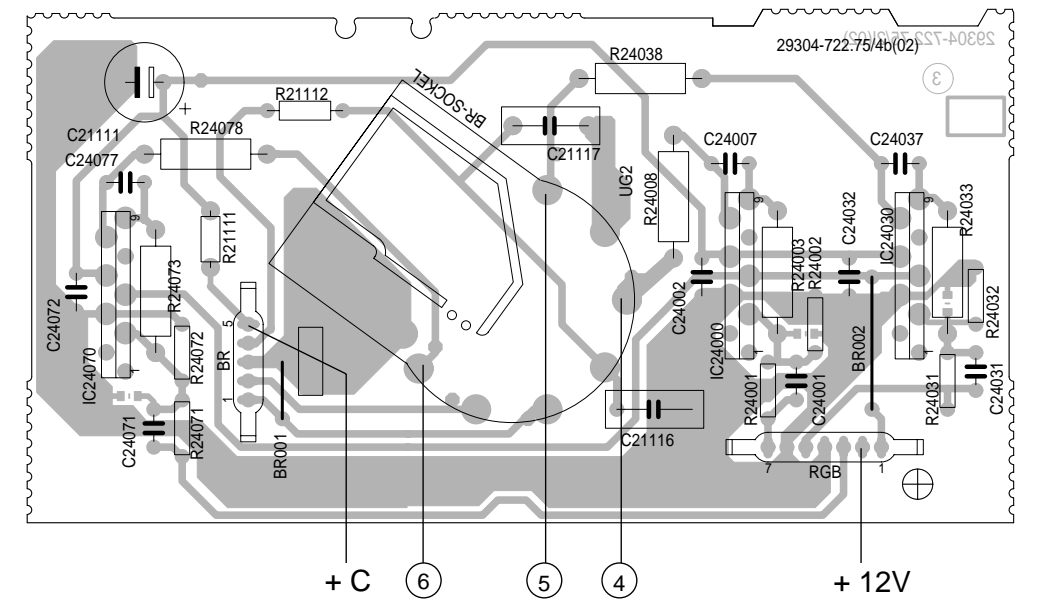

BILDROHRPLATTE 29305-122.08 14"  
CRT PANEL  
C.I. TUBE CATHOD.  
PIASTRA CINESC.  
PLACA ZOCALO TRC  
-122.09 15"...21"

| *       | CR24002<br>CR24032<br>CR24072 | R24003<br>R24033<br>R24073 | R21111 | BR6 |
|---------|-------------------------------|----------------------------|--------|-----|
| -122.08 | 1,5k                          | 47k                        | —      | —   |
| -122.09 | 1,1k                          | 56k                        | 330    | —   |

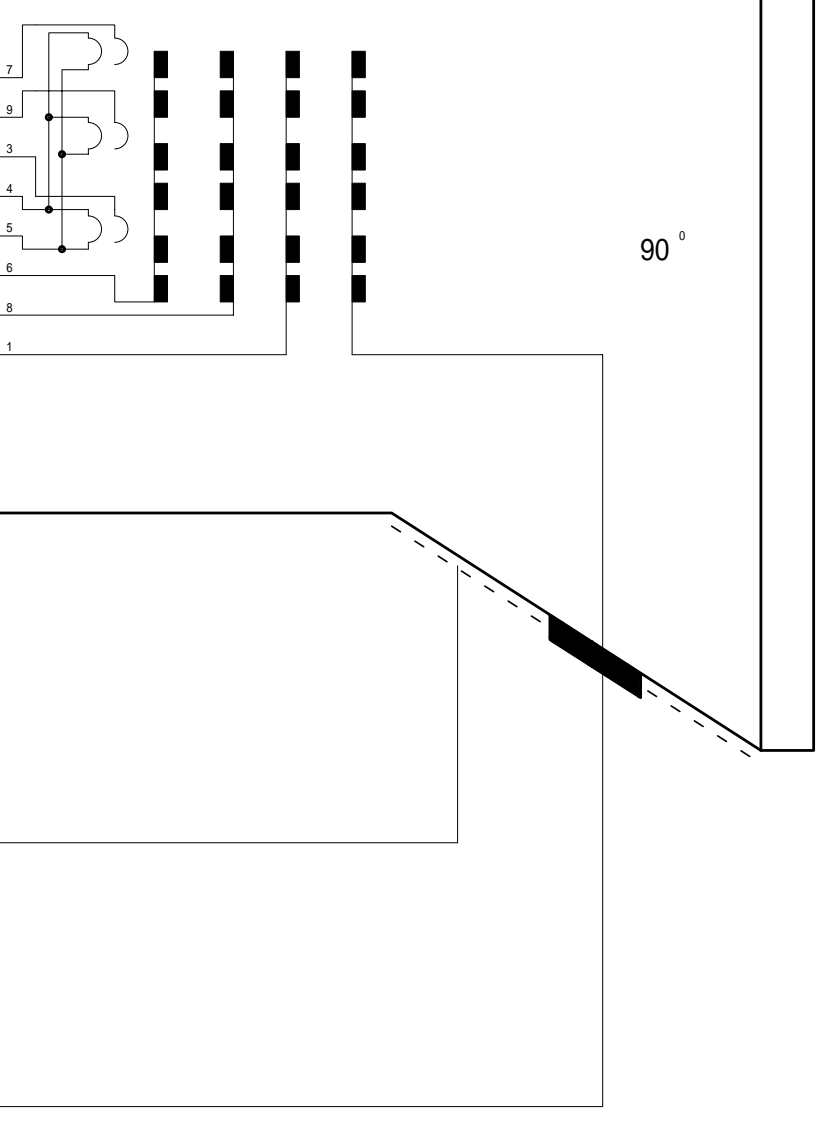
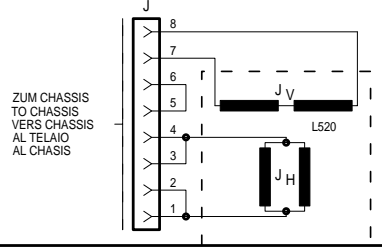

**Bildrohrplatte / CRT Panel 29305-022.17**

**Bestückungsseite, Ansicht von oben  
Component side, top view**

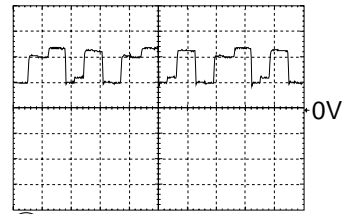

④ 50V/cm, 20µs/cm

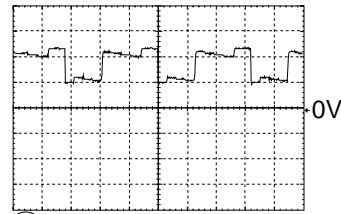

⑤ 50V/cm, 20µs/cm

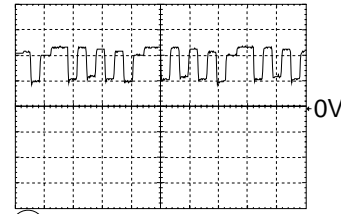

⑥ 50V/cm, 20µs/cm

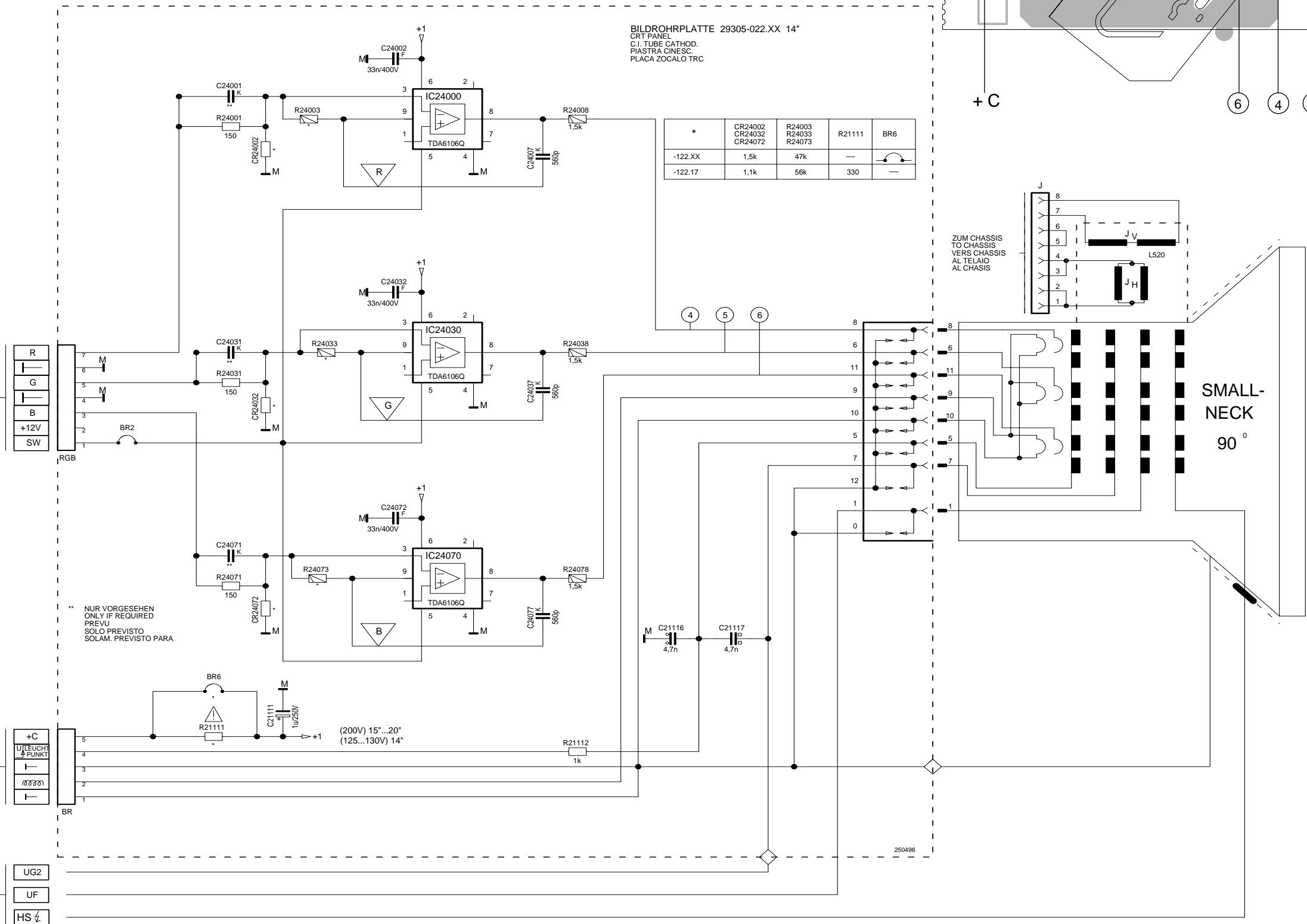
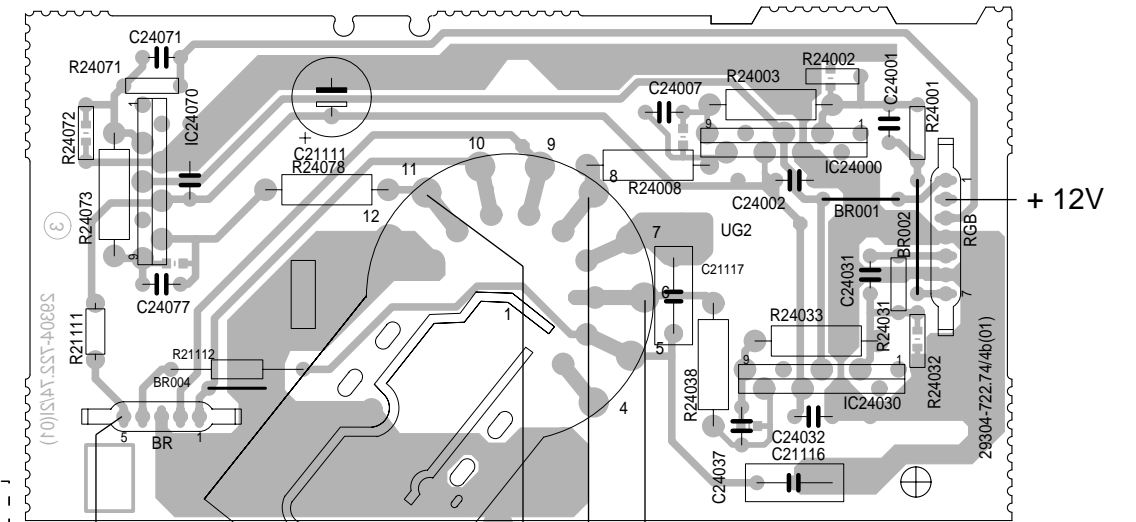

# GRUNDIG Ersatzteilliste Spare Parts List

7 / 96

Btx \* 32700 #

CUC 7350

| POS. NR.<br>POS. NO. | ABB.<br>FIG. | SACHNUMMER<br>PART NUMBER | ANZ.<br>QUA. | BEZEICHNUNG<br>DESCRIPTION                 | (D) | BEZEICHNUNG<br>DESCRIPTION              |
|----------------------|--------------|---------------------------|--------------|--|-----|---|
| 0001.000             |              | 29504-201.31              |              | TUNER CHIP/ECO 1200                        |     | TUNER CHIP/ECO 1200                     |
| 0002.000             |              | 29504-102.40              | X            | CHIP-TUNER/ATA 1200                        |     | CHIP-TUNER/ATA 1200                     |
| 0003.000             |              | 29504-162.39              | X            | BAUSTEIN ZE-TON 07/16/17/19                |     | MODULE IF SOUND 07/16/17/19             |
| 0004.000             |              | 29504-162.57              | X            | BAUSTEIN ZE-TON NICAM 04/18/20             |     | MODULE IF SOUND NICAM 04/18/20          |
| 0005.000             |              | 29504-108.89              | X            | BAUSTEIN VIDEO-TEXT 20                     |     | MODULE VIDEO-TEXT 20                    |
| 0006.000             |              | 29303-119.04              | X            | EURO-KV BUCHSE Z-FHOL                      |     | PERI-SOCKET Z-FIN                       |
| 0007.000             |              | 29303-166.05              |              | CINCHBUCHSE 3-FACH                         |     | CINCH SOCKET 3 FOLD                     |
| 0008.000             |              | 29303-390.41              |              | BUCHSENABDECKUNG                           |     | EAR PHONE SOCKET                        |
| 0009.000             |              | 29700-611.03              |              | NETZSCHALTER ECO O.W. 04/07/17/19          |     | POWER SWITCH 04/07/17/19                |
| 0010.000             |              | 29703-291.71              |              | NETZSCHALTER 16/18/20                      |     | POWER SWITCH 16/18/20                   |
| 0011.000             |              | 29703-291.21              |              | NETZSCHALTER 16/18/20                      |     | POWER SWITCH 16/18/20                   |
| 0012.000             |              | 29703-357.11              | 4            | TASTENSCHALTER                             |     | KEY SWITCH                              |
| 0013.000             |              | 29303-153.02              |              | MONTAGECLIP T53001/IC50010/40010           |     | MOUNTING CLIP T53001/IC50010/40010      |
| 0014.000             |              | 29303-153.16              |              | MONTAGECLIP T60020/IC61010/0256/030        |     | MOUNTING CLIP T60020/IC61010/0256/030   |
| 0015.000             |              | 29303-156.23              |              | FOLIE WAERMELEITEND T53001                 |     | HEAT CONDUCTING FOIL T53001             |
| 0016.000             |              | 29303-156.20              |              | FOLIE WAERMELEITEND T60020/IC61010         |     | HEAT CONDUCTING FOIL T60020/IC61010     |
| 0017.000             |              | 29303-399.51              |              | NETZ ENBAUGERAETE/TESTECKER 07/16/18/19/20 |     | POWER BUILT-IN APPLIANCE 07/16/18/19/20 |
| 0018.000             |              | 29303-399.52              |              | NETZ ENBAUGERAETE/TESTECKER 04/17          |     | POWER BUILT-IN APPLIANCE 04/17          |
| 0019.000             |              | 29210-703.01              | 2            | FOKUSLEITUNG                               |     | FOCUSING CABLE                          |
| 0020.000             |              | 09621-113.02              |              | SICHERUNGSHALTER                           |     | FUSE HOLDER                             |
| 0021.000             |              | 29502-460.29              |              | ZF-ABDECKUNG 07/19                         |     | IF COVER 07/19                          |
| 0022.000             |              | 29305-119.23              |              | PROZESSORPLATTE 07                         |     | PROCESSOR BOARD                         |
|                      |              | 72010-016.80              |              | KEIN E-TEIL                                |     | NO SPARE PART                           |
|                      |              |                           |              | SERVICE MANUAL                             |     | SERVICE MANUAL                          |
|                      |              |                           |              | X = SIEHE GESONDERTE E-LISTE               |     | X = SEE SEPARATE PARTS LIST             |
|                      |              |                           |              | WW. = WAHLWEISE                            |     | WW. = WAHLWEISE                         |

| POS. NR.<br>POS. NO. | ABB.<br>FIG. | SACHNUMMER<br>PART NUMBER | ANZ.<br>QUA. | BEZEICHNUNG<br>DESCRIPTION | (D) | BEZEICHNUNG<br>DESCRIPTION |
|----------------------|--------------|---------------------------|--------------|----------------------------|-----|----------------------------|
| C 40006              |              | 8452-996-150              |              | ELKO 2200UF 20% 25V        |     | SMD DIODE LS 4148          |
| C 40031              |              | 8452-996-147              |              | ELKO 1000UF 20% 25V        |     | SMD DIODE LS 4148          |
| C 40041              |              | 8452-996-147              |              | ELKO 1000UF 20% 25V        |     | SMD DIODE LS 4148          |
| C 53001              |              | 8515-911-102              |              | FKP1 8500PF 3.5% 1500V     |     | SMD DIODE LS 4148          |
| C 54007              |              | 8452-996-187              |              | ELKO 1000UF 20% 35V        |     | SMD DIODE LS 4148          |
| C 60011              |              | 8650-081-125              |              | HV-KERKO 1000PF 20% 1KV    |     | SMD DIODE LS 4148          |
| C 60012              |              | 8650-081-125              |              | HV-KERKO 1000PF 20% 1KV    |     | SMD DIODE LS 4148          |
| C 60013              |              | 8650-081-125              |              | HV-KERKO 1000PF 20% 1KV    |     | SMD DIODE LS 4148          |
| C 60014              |              | 8650-081-125              |              | HV-KERKO 1000PF 20% 1KV    |     | SMD DIODE LS 4148          |
| C 60015              |              | 8650-081-125              |              | HV-KERKO 1000PF 20% 1KV    |     | SMD DIODE LS 4148          |
| C 60016              |              | 8650-081-125              |              | HV-KERKO 1000PF 20% 1KV    |     | SMD DIODE LS 4148          |
| C 60017              |              | 8650-081-125              |              | HV-KERKO 1000PF 20% 1KV    |     | SMD DIODE LS 4148          |
| C 60018              |              | 8650-081-125              |              | HV-KERKO 1000PF 20% 1KV    |     | SMD DIODE LS 4148          |
| C 60019              |              | 8650-081-125              |              | HV-KERKO 1000PF 20% 1KV    |     | SMD DIODE LS 4148          |
| C 60020              |              | 8650-081-125              |              | HV-KERKO 1000PF 20% 1KV    |     | SMD DIODE LS 4148          |
| C 60021              |              | 8650-081-125              |              | HV-KERKO 1000PF 20% 1KV    |     | SMD DIODE LS 4148          |
| C 60022              |              | 8650-081-125              |              | HV-KERKO 1000PF 20% 1KV    |     | SMD DIODE LS 4148          |
| C 60023              |              | 8650-081-125              |              | HV-KERKO 1000PF 20% 1KV    |     | SMD DIODE LS 4148          |
| C 60024              |              | 8650-081-125              |              | HV-KERKO 1000PF 20% 1KV    |     | SMD DIODE LS 4148          |
| C 60025              |              | 8650-081-125              |              | HV-KERKO 1000PF 20% 1KV    |     | SMD DIODE LS 4148          |
| C 60026              |              | 8650-081-125              |              | HV-KERKO 1000PF 20% 1KV    |     | SMD DIODE LS 4148          |
| C 60027              |              | 8650-081-125              |              | HV-KERKO 1000PF 20% 1KV    |     | SMD DIODE LS 4148          |
| C 60028              |              | 8650-081-125              |              | HV-KERKO 1000PF 20% 1KV    |     | SMD DIODE LS 4148          |
| C 60029              |              | 8650-081-125              |              | HV-KERKO 1000PF 20% 1KV    |     | SMD DIODE LS 4148          |
| C 60030              |              | 8650-081-125              |              | HV-KERKO 1000PF 20% 1KV    |     | SMD DIODE LS 4148          |
| C 60031              |              | 8650-081-125              |              | HV-KERKO 1000PF 20% 1KV    |     | SMD DIODE LS 4148          |
| C 60032              |              | 8650-081-125              |              | HV-KERKO 1000PF 20% 1KV    |     | SMD DIODE LS 4148          |
| C 60033              |              | 8650-081-125              |              | HV-KERKO 1000PF 20% 1KV    |     | SMD DIODE LS 4148          |
| C 60034              |              | 8650-081-125              |              | HV-KERKO 1000PF 20% 1KV    |     | SMD DIODE LS 4148          |
| C 60035              |              | 8650-081-125              |              | HV-KERKO 1000PF 20% 1KV    |     | SMD DIODE LS 4148          |
| C 60036              |              | 8650-081-125              |              | HV-KERKO 1000PF 20% 1KV    |     | SMD DIODE LS 4148          |
| C 60037              |              | 8650-081-125              |              | HV-KERKO 1000PF 20% 1KV    |     | SMD DIODE LS 4148          |
| C 60038              |              | 8650-081-125              |              | HV-KERKO 1000PF 20% 1KV    |     | SMD DIODE LS 4148          |
| C 60039              |              | 8650-081-125              |              | HV-KERKO 1000PF 20% 1KV    |     | SMD DIODE LS 4148          |
| C 60040              |              | 8650-081-125              |              | HV-KERKO 1000PF 20% 1KV    |     | SMD DIODE LS 4148          |
| C 60041              |              | 8650-081-125              |              | HV-KERKO 1000PF 20% 1KV    |     | SMD DIODE LS 4148          |
| C 60042              |              | 8650-081-125              |              | HV-KERKO 1000PF 20% 1KV    |     | SMD DIODE LS 4148          |
| C 60043              |              | 8650-081-125              |              | HV-KERKO 1000PF 20% 1KV    |     | SMD DIODE LS 4148          |
| C 60044              |              | 8650-081-125              |              | HV-KERKO 1000PF 20% 1KV    |     | SMD DIODE LS 4148          |
| C 60045              |              | 8650-081-125              |              | HV-KERKO 1000PF 20% 1KV    |     | SMD DIODE LS 4148          |
| C 60046              |              | 8650-081-125              |              | HV-KERKO 1000PF 20% 1KV    |     | SMD DIODE LS 4148          |
| C 60047              |              | 8650-081-125              |              | HV-KERKO 1000PF 20% 1KV    |     | SMD DIODE LS 4148          |
| C 60048              |              | 8650-081-125              |              | HV-KERKO 1000PF 20% 1KV    |     | SMD DIODE LS 4148          |
| C 60049              |              | 8650-081-125              |              | HV-KERKO 1000PF 20% 1KV    |     | SMD DIODE LS 4148          |
| C 60050              |              | 8650-081-125              |              | HV-KERKO 1000PF 20% 1KV    |     | SMD DIODE LS 4148          |
| C 60051              |              | 8650-081-125              |              | HV-KERKO 1000PF 20% 1KV    |     | SMD DIODE LS 4148          |
| C 60052              |              | 8650-081-125              |              | HV-KERKO 1000PF 20% 1KV    |     | SMD DIODE LS 4148          |
| C 60053              |              | 8650-081-125              |              | HV-KERKO 1000PF 20% 1KV    |     | SMD DIODE LS 4148          |
| C 60054              |              | 8650-081-125              |              | HV-KERKO 1000PF 20% 1KV    |     | SMD DIODE LS 4148          |
| C 60055              |              | 8650-081-125              |              | HV-KERKO 1000PF 20% 1KV    |     | SMD DIODE LS 4148          |
| C 60056              |              | 8650-081-125              |              | HV-KERKO 1000PF 20% 1KV    |     | SMD DIODE LS 4148          |
| C 60057              |              | 8650-081-125              |              | HV-KERKO 1000PF 20% 1KV    |     | SMD DIODE LS 4148          |
| C 60058              |              | 8650-081-125              |              | HV-KERKO 1000PF 20% 1KV    |     | SMD DIODE LS 4148          |
| C 60059              |              | 8650-081-125              |              | HV-KERKO 1000PF 20% 1KV    |     | SMD DIODE LS 4148          |
| C 60060              |              | 8650-081-125              |              | HV-KERKO 1000PF 20% 1KV    |     | SMD DIODE LS 4148          |
| C 60061              |              | 8650-081-125              |              | HV-KERKO 1000PF 20% 1KV    |     | SMD DIODE LS 4148          |
| C 60062              |              | 8650-081-125              |              | HV-KERKO 1000PF 20% 1KV    |     | SMD DIODE LS 4148          |
| C 60063              |              | 8650-081-125              |              | HV-KERKO 1000PF 20% 1KV    |     | SMD DIODE LS 4148          |
| C 60064              |              | 8650-081-125              |              | HV-KERKO 1000PF 20% 1KV    |     | SMD DIODE LS 4148          |
| C 60065              |              | 8650-081-125              |              | HV-KERKO 1000PF 20% 1KV    |     | SMD DIODE LS 4148          |
| C 60066              |              | 8650-081-125              |              | HV-KERKO 1000PF 20% 1KV    |     | SMD DIODE LS 4148          |
| C 60067              |              | 8650-081-125              |              | HV-KERKO 1000PF 20% 1KV    |     | SMD DIODE LS 4148          |
| C 60068              |              | 8650-081-125              |              | HV-KERKO 1000PF 20% 1KV    |     | SMD DIODE LS 4148          |
| C 60069              |              | 8650-081-125              |              | HV-KERKO 1000PF 20% 1KV    |     | SMD DIODE LS 4148          |
| C 60070              |              | 8650-081-125              |              | HV-KERKO 1000PF 20% 1KV    |     | SMD DIODE LS 4148          |
| C 60071              |              | 8650-081-125              |              | HV-KERKO 1000PF 20% 1KV    |     | SMD DIODE LS 4148          |
| C 60072              |              | 8650-081-125              |              | HV-KERKO 1000PF 20% 1KV    |     | SMD DIODE LS 4148          |
| C 60073              |              | 8650-081-125              |              | HV-KERKO 1000PF 20% 1KV    |     | SMD DIODE LS 4148          |
| C 60074              |              | 8650-081-125              |              | HV-KERKO 1000PF 20% 1KV    |     | SMD DIODE LS 4148          |
| C 60075              |              | 8650-081-125              |              | HV-KERKO 1000PF 20% 1KV    |     | SMD DIODE LS 4148          |
| C 60076              |              | 8650-081-125              |              | HV-KERKO 1000PF 20% 1KV    |     | SMD DIODE LS 4148          |
| C 60077              |              | 8650-081-125              |              | HV-KERKO 1000PF 20% 1KV    |     | SMD DIODE LS 4148          |
| C 60078              |              | 8650-081-125              |              | HV-KERKO 1000PF 20% 1KV    |     | SMD DIODE LS 4148          |
| C 60079              |              | 8650-081-125              |              | HV-KERKO 1000PF 20% 1KV    |     | SMD DIODE LS 4148          |
| C 60080              |              | 8650-081-125              |              | HV-KERKO 1000PF 20% 1KV    |     | SMD DIODE LS 4148          |
| C 60081              |              | 8650-081-125              |              | HV-KERKO 1000PF 20% 1KV    |     | SMD DIODE LS 4148          |
| C 60082              |              | 8650-081-125              |              | HV-KERKO 1000PF 20% 1KV    |     | SMD DIODE LS 4148          |
| C 60083              |              | 8650-081-125              |              | HV-KERKO 1000PF 20% 1KV    |     | SMD DIODE LS 4148          |
| C 60084              |              | 8650-081-125              |              | HV-KERKO 1000PF 20% 1KV    |     | SMD DIODE LS 4148          |
| C 60085              |              | 8650-081-125              |              | HV-KERKO 1000PF 20% 1KV    |     | SMD DIODE LS 4148          |
| C 60086              |              | 8650-081-125              |              | HV-KERKO 1000PF 20% 1KV    |     | SMD DIODE LS 4148          |
| C 60087              |              | 8650-081-125              |              | HV-KERKO 1000PF 20% 1KV    |     | SMD DIODE LS 4148          |
| C 60088              |              | 8650-081-125              |              | HV-KERKO 1000PF 20% 1KV    |     | SMD DIODE LS 4148          |
| C 60089              |              | 8650-081-125              |              | HV-KERKO 1000PF 20% 1KV    |     | SMD DIODE LS 4148          |
| C 60090              |              | 8650-081-125              |              | HV-KERKO 1000PF 20% 1KV    |     | SMD DIODE LS 4148          |
| C 60091              |              | 8650-081-125              |              | HV-KERKO 1000PF 20% 1KV    |     | SMD DIODE LS 4148          |
| C 60092              |              | 8650-081-125              |              | HV-KERKO 1000PF 20% 1KV    |     | SMD DIODE LS 4148          |
| C 60093              |              | 8650-081-125              |              | HV-KERKO 1000PF 20% 1KV    |     | SMD DIODE LS 4148          |
| C 60094              |              | 8650-081-125              |              | HV-KERKO 1000PF 20% 1KV    |     | SMD DIODE LS 4148          |
| C 60095              |              | 8650-081-125              |              | HV-KERKO 1000PF 20% 1KV    |     | SMD DIODE LS 4148          |
| C 60096              |              | 8650-081-125              |              | HV-KERKO 1000PF 20% 1KV    |     | SMD DIODE LS 4148          |
| C 60097              |              | 8650-081-125              |              | HV-KERKO 1000PF 20% 1KV    |     | SMD DIODE LS 4148          |
| C 60098              |              | 8650-081-125              |              | HV-KERKO 1000PF 20% 1KV    |     | SMD DIODE LS 4148          |
| C 60099              |              | 8650-081-125              |              | HV-KERKO 1000PF 20% 1KV    |     | SMD DIODE LS 4148          |
| C 60100              |              | 8650-081-125              |              | HV-KERKO 1000PF 20% 1KV    |     | SMD DIODE LS 4148          |
| C 60101              |              | 8650-081-125              |              | HV-KERKO 1000PF 20% 1KV    |     | SMD DIODE LS 4148          |
| C 60102              |              | 8650-081-125              |              | HV-KERKO 1000PF 20% 1KV    |     | SMD DIODE LS 4148          |
| C 60103              |              | 8650-081-125              |              | HV-KERKO 1000PF 20% 1KV    |     | SMD DIODE LS 4148          |
| C 60104              |              | 8650-081-125              |              | HV-KERKO 1000PF 20% 1KV    |     | SMD DIODE LS 4148          |
| C 60105              |              | 8650-081-125              |              | HV-KERKO 1000PF 20% 1KV    |     | SMD DIODE LS 4148          |
| C 60106              |              | 8650-081-125              |              | HV-KERKO 1000PF 20% 1KV    |     | SMD DIODE LS 4148          |
| C 60107              |              | 8650-081-125              |              | HV-KERKO 1000PF 20% 1KV    |     | SMD DIODE LS 4148          |
| C 60108              |              | 8650-081-125              |              | HV-KERKO 1000PF 20% 1KV    |     | SMD DIODE LS 4148          |
| C 60109              |              | 8650-081-125              |              | HV-KERKO 1000PF 20% 1KV    |     | SMD DIODE LS 4148          |
| C 60110              |              | 8650-081-125              |              | HV-KERKO 1000PF 20% 1KV    |     | SMD DIODE LS 4148          |
| C 60111              |              | 8650-081-125              |              | HV-KERKO 1000PF 20% 1KV    |     | SMD DIODE LS 4148          |
| C 60112              |              | 8650-081-125              | </           |                            |     |                            |

**GRUNDIG**Ersatzteilliste  
Spare Parts List

D Btx \* 32700 #

11 / 95

ST 55-876/9 TEXT

LISSABON SE 5576 TEXT

SACH-NR. / PART NO.: 9.21436-1175 BESTELL-NR. / ORDER NO.: G.CB 5375 FB COSMOS-SCHWARZ/COSMOS BLACK  
SACH-NR. / PART NO.: 9.21434-0175 BESTELL-NR. / ORDER NO.: G.CB 5475 COSMOS-SCHWARZ/COSMOS BLACK

| POS. NR.<br>POS. NO. | ABB.<br>FIG. | SACHNUMMER<br>PART NUMBER | ANZ.<br>QTY. | BEZEICHNUNG<br>D  | DESCRIPTION<br>GB   |
|----------------------|--------------|---------------------------|--------------|---|---|
| 0001.000             |              | 29625-736.01              |              | GEHAEUSEVORDERTEIL OFB  | CABINET FRONT OFB   |
| 0001.100             |              | 29602-605.51              |              | GRUNDIG EMBLEM  | GRUNDIG EMBLEM  |
| 0001.200             |              | 29633-802.01              |              | ABDECKUNG DRUCK KPL 11  | COVER PRESURE CPL. 11   |
| 0001.200             |              | 29633-800.01              |              | ABDECKUNG DRUCK KPL 01  | COVER PRESURE CPL. 01   |
| 0006.000             |              | 29628-758.01              |              | CHASSISBEFESTIGUNG  | CHASSIS FASTENING   |
| 0007.000             |              | 19126-024.97              | 2            | LAUTSPRECHER  | LOUDSPEAKER   |
| 0009.000             |              | 29631-940.86              |              | GEHAEUSERUECKTEIL   | REAR PANEL  |
| 0010.000             |              | 29618-090.14              |              | AUFKLEBER TYPE 11   | ADHESIVE LABEL;STICKER 11                                       |
| 0010.000             |              | 29618-088.14              |              | AUFKLEBER TYPE 01   | ADHESIVE LABEL;STICKER 01                                       |
|                      |              | 29656-002.94              |              | MONTAGE-ZUBEHOER F.BILDROHR<br>KEIN E-TEIL                        | MOUNTING ACCESSORIES FOR CRT<br>NO SPARE PART                   |
| 0021.000             |              | 29607-222.01              |              | SPULENLASCHE  | COIL STRAP  |
| 0022.000             |              | 29607-217.01              | 2            | SPULENKLAMMER UNTEN   | COIL CLIP LOWER   |
| WW.                  |              | 29607-218.01              | 2            | SPULENKLAMMER UNTEN   | COIL CLIP LOWER   |
| 0023.000             |              | 29607-284.11              | 2            | SPULENKLAMMER OBEN  | COIL CLIP UPPER   |
| WW.                  |              | 29607-285.11              | 2            | SPULENKLAMMER OBEN  | COIL CLIP UPPER   |
| 0024.000             | △            | 09246-193.31              |              | ENTMAGNETISIERUNGSSPULE   | DEGAUSSING COIL   |
| WW.                  | △            | 09246-193.71              |              | ENTMAGNETISIERUNGSSPULE   | DEGAUSSING COIL   |
| 0025.000             | △            | 8300-020-655              |              | BILDR.A 51 EAL 155X01   | PICT.TUBE A 51 EAL 155X01                                       |
| 0026.000             | △            | 29201-360.01              |              | ANODENKAPPE MIT HOCHSPG.-KABEL                                    | C.R.T. SOCKET   |
| 0027.000             |              | 29633-789.01              |              | TASTENSATZ  | KEY SET   |
| 0029.000             |              | 29633-804.01              |              | ABDECKUNG CINCHBUCHSEN  | COVER   |
| 0030.000             |              | 29633-790.01              |              | TASTENKNOPF NETZ 11   | KEY BUTTON MAINS 11   |
| 0030.000             |              | 29633-790.02              |              | TASTENKNOPF NETZ 01   | KEY BUTTON MAINS 01   |
| 0033.000             | △            | 8290-991-316              |              | NETZKABEL KPL   | POWER CABLE CPL GWN9.22   |
| 0034.000             |              | 29642-059.06              |              | TELEPILOT TP 720  | REMOTE CONTROL TP 720   |
|                      |              | 29305-022.17              | X            | BILDROHRPLATTE  | PICTURE TUBE BOARD  |
|                      |              | 29701-093.18              | X            | CHASSIS-FS-STEREO 11<br>CUC 7350<br>KEIN E-TEIL                   | CHSSIS TV STEREO 11<br>CUC 7350<br>NO SPARE PART                |
|                      |              | 29701-093.19              | X            | CHASSIS-FS-STEREO 01<br>CUC 7350<br>KEIN E-TEIL                   | CHSSIS TV STEREO 01<br>CUC 7350<br>NO SPARE PART                |
|                      |              | 21436-941.01              |              | BEDIENUNGSANLEITUNG   | INSTRUCTION MANUAL  |
|                      |              | 72010-016.81              |              | SERVICE MANUAL<br>X = SIEHE GESONDERTE E-LISTE<br>WW. = WAHLWEISE | SERVICE MANUAL<br>X = SEE SEPARATE PARTS LIST<br>WW. = OPTIONAL |

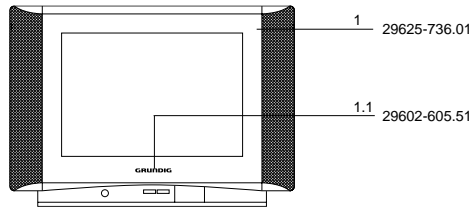

Es gelten die Vorschriften und Sicherheitshinweise gemäß dem Service Manual "Sicherheit", Sach-Nummer 72010-800.00, sowie zusätzlich die eventuell abweichenden, landesspezifischen Vorschriften!



The regulations and safety instructions shall be valid as provided by the "Safety" Service Manual, part number 72010-800.00, as well as the respective national deviations.

**GRUNDIG**Ersatzteilliste  
Spare Parts List

D Btx \* 32700 #

7 / 95

XS 55/1

XS 55/9

SACH-NR. / PART NO.: 9.21378-0175 BESTELL-NR. / ORDER NO.: G.CB 9675 COSMOS-SCHWARZ/COSMOS-BLACK  
SACH-NR. / PART NO.: 9.21378-0275 BESTELL-NR. / ORDER NO.: G.CB 9775 COSMOS-SCHWARZ/COSMOS-BLACK

| POS. NR.<br>POS. NO. | ABB.<br>FIG. | SACHNUMMER<br>PART NUMBER | ANZ.<br>QUA. | BEZEICHNUNG<br>D                                | DESCRIPTION<br>GB                                 |
|----------------------|--------------|---------------------------|--------------|---|---|
| 0001.000             |              | 29625-638.04              |              | GEHAEUSEVORDERTEIL OFB                          | CABINET FRONT OFB                                 |
| 0001.100             |              | 29602-603.51              |              | GRUNDIG-EMBLEM                                  | GRUNDIG EMBLEM                                    |
| 0001.200             |              | 29628-603.55              | 2            | GITTER KPL                                      | GRID, GRILLE CPL.                                 |
| 0001.300             |              | 29633-238.01              |              | ABDECKUNG DRUCK KPL                             | COVER PRESSURE CPL.                               |
| 0005.000             |              | 19126-024.97              | 2            | LAUTSPRECHER                                    | LOUDSPEAKER                                       |
| 0006.000             |              | 29628-758.01              | 2            | CHASSISBEFESTIGUNG                              | CHASSIS FASTENING                                 |
| 0008.000             |              | 29631-897.86              |              | GEHAEUSERUECKTEIL                               | REAR PANEL  |
| 0009.000             |              | 29618-001.14              |              | AUFKLEBER TYPE 01                               | ADHESIVE LABEL;STICKER 01                         |
| 0009.000             |              | 29618-002.14              |              | AUFKLEBER TYPE 02                               | ADHESIVE LABEL;STICKER 02                         |
|                      |              | 29656-002.94              |              | MONTAGE-ZUBEHOER F.BILDROHR<br>KEIN E-TEIL      | MOUNTING ACCESSORIES FOR CRT<br>NO SPARE PART     |
| 0021.000             |              | 29607-217.01              | 2            | SPULENKLAMMER UNTEN                             | COIL CLIP BOTTOM                                  |
| WW.                  |              | 29607-218.01              | 2            | SPULENKLAMMER UNTEN                             | COIL CLIP BOTTOM                                  |
| 0022.000             |              | 29607-222.01              |              | SPULENLASCHE                                    | COIL STRAP  |
| 0023.000             |              | 29607-284.11              | 2            | SPULENKLAMMER OBEN                              | COIL CLIP UPPER                                   |
| WW.                  |              | 29607-285.11              | 2            | SPULENKLAMMER OBEN                              | COIL CLIP UPPER                                   |
| 0024.000             | △            | 09246-193.31              |              | ENTMAGNETISIERUNGSSPULE                         | DEGAUSSING COIL                                   |
| WW.                  | △            | 09246-193.71              |              | ENTMAGNETISIERUNGSSPULE                         | DEGAUSSING COIL                                   |
| 0025.000             | △            | 8300-020-534              |              | BILDR.A 51 JSW 90X03 ORI 01/02                  | PICT.TUBE A 51 JSW 90X03 01/02                    |
| 0026.000             | △            | 8300-020-532              |              | BILDR.A 51 EAM 31X01 PHI 02                     | PICT.TUBE A 51 EAM 31X01 02                       |
| WW.                  | △            | 8300-020-533              |              | BILDR.A 51 JAR 43X01 (MW) 01/02                 | PICT.TUBE A 51 JAR 43X01 01/02                    |
| 0026.000             | △            | 29201-360.01              |              | ANODENKAPPE M. HOCHSPG.-KABEL                   | C.R.T. SOCKET                                     |
| 0030.000             |              | 29501-082.14              |              | BEDIENEINHEIT                                   | CONTROL UNIT                                      |
| 0030.100             |              | 29303-390.63              |              | KOPFHOERERBUCHSE                                | EAR PHONE SOCKET                                  |
| 0030.200             |              | 29501-512.01              |              | TASTENSATZ                                      | KEYS SET  |
| 0030.400             | △            | 29703-291.21              |              | NETZSCHALTER                                    | POWER SWITCH                                      |
| WW.                  | △            | 29703-291.31              |              | NETZSCHALTER                                    | POWER SWITCH                                      |
| 0030.600             |              | 29703-357.01              | 4            | TASTSCHALTER KEYBOARDPLATTE                     | TACT SWITCH                                       |
| 0052.000             |              | 29633-031.01              |              | TASTENKNOPF NETZ                                | KEY KNOB MAINS                                    |
| 0053.000             | △            | 8290-991-316              |              | NETZKABEL KPL                                   | POWER CABLE CPL GWN9.22                           |
| 0054.000             | △            | 29642-063.01              |              | TELEPILOT TP 712                                | REMOTE CONTROL TP 712                             |
|                      |              | 29305-122.09              | X            | BILDROHRPLATTE                                  | PICTURE TUBE BOARD                                |
|                      |              | 21378-941.01              |              | BEDIENUNGSANLEITUNG 01                          | INSTRUCTION MANUAL 01                             |
|                      |              | 21378-941.02              |              | BEDIENUNGSANLEITUNG 02                          | INSTRUCTION MANUAL 02                             |
|                      |              | 29701-093.17              | X            | CHASSIS-FS-STEREO 01<br>CUC 7350<br>KEIN E-TEIL | CHASSIS-TV-STEREO 01<br>CUC 7350<br>NO SPARE PART |
|                      |              | 29701-093.04              | X            | CHASSIS-FS-STEREO 02<br>CUC 7350<br>KEIN E-TEIL | CHASSIS-TV-STEREO 02<br>CUC 7350<br>NO SPARE PART |
|                      |              | 72010-016.81              |              | SERVICE MANUAL                                  | SERVICE MANUAL                                    |
|                      |              |                           |              | X = SIEHE GESONDERTE E-LISTE<br>WW. = WAHLWEISE | X = SEE SEPARATE PARTS LIST<br>WW. = OPTIONAL     |

| POS. NR.<br>POS. NO. | SACHNUMMER<br>PART NUMBER | BEZEICHNUNG<br>DESCRIPTION | (D)<br>(GB) |
|----------------------|---------------------------|----------------------------|-------------|
| C41504               | 8668-203-023              | ABBLOCK-C 0,1 UF -GR       |             |
| D85001               | 8309-944-601              | LE DIODE TLHR 4601 TFK     |             |
| IC84001              | 8305-367-530              | IC TFMS 5300               |             |
| R60000               | 8765-049-157              | MSW AX 0414-GA 3,3 MOHM    |             |

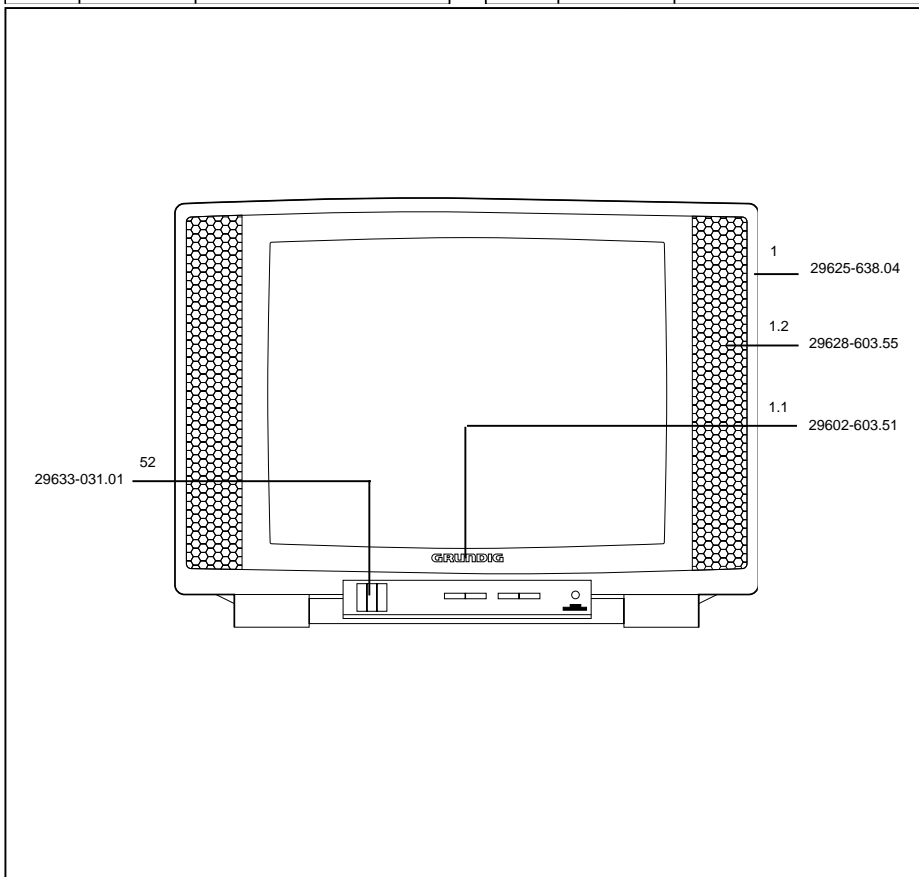

Es gelten die Vorschriften und Sicherheitshinweise gemäß dem Service Manual "Sicherheit", Sach-Nummer 72010-800.00, sowie zusätzlich die eventuell abweichenden, landesspezifischen Vorschriften!



The regulations and safety instructions shall be valid as provided by the "Safety" Service Manual, part number 72010-800.00, as well as the respective national deviations.

# GRUNDIG

## Ersatzteilliste Spare Parts List



(D) Btx \* 32700 #

7 / 95

SP 737 TEXT GREENVILLE

SACH-NR. / PART NO.: 9.21416-0175  
BESTELL-NR. / ORDER NO.: G.CB 9975 COSMOS-SCHWARZ/COSMOS-BLACK

| POS. NR.<br>POS. NO. | ABB. NR.<br>FIG. NO. | SACHNUMMER<br>PART NUMBER | ANZ.<br>QUA. | BEZEICHNUNG<br>DESCRIPTION                   | (D)<br>(GB)                                    |
|----------------------|----------------------|---------------------------|--------------|--|--|
| 0001.000             |                      | 29625-676.02              |              | GEHAEUSEVORDERTEIL OFB                       | CABINET FRONT OFB                              |
| 0001.100             |                      | 29632-082.01              |              | GRUNDIG EMBLEM                               | GRUNDIG EMBLEM                                 |
| 0001.200             |                      | 29628-758.01              |              | CHASSISBEFESTIGUNG                           | CHASSIS FASTENING                              |
| 0001.300             |                      | 29633-315.03              |              | ABDECKUNG KPL                                | COVER  |
| 0007.000             |                      | 19144-041.97              | 2            | LAUTSPRECHER                                 | LOUDSPEAKER                                    |
| 0007.100             |                      | 29700-621.01              | 2            | MONTAGE-FEDER F. LS-BEFEST.                  | ASSEMBLY SPRING                                |
| 0008.000             |                      | 29631-782.87              |              | GEHAEUSERUECKTEIL                            | REAR PANEL                                     |
| 0009.000             |                      | 29618-006.14              |              | AUFKLEBER TYPE                               | ADHESIVE LABEL;STICKER                         |
| 0010.000             |                      | 29501-616.02              |              | TASTENSATZ                                   | KEY SET  |
| 0011.000             |                      | 29620-017.01              |              | ANTENNE TELESKOP EINSTAB                     | ANTENNA (USA); AERIAL (GB)                     |
|                      |                      | 29656-002.61              |              | MONTAGE-ZUBEHOER F. BILDROHR<br>KEIN E-TEIL  | MOUNTING ACCESSORIES FOR CRT<br>NO SPARE PART  |
| 0024.000             | △                    | 09246-184.71              |              | ENTMAGNETISIERUNGSSPULE                      | DEGAUSSING COIL                                |
| 0025.000             | △                    | 8300-020-037              |              | BILDR.A 34 EAC 01X06 PHI                     | PICT.TUBE A 34 EAC 01X06                       |
| 0026.000             | △                    | 29201-360.01              |              | ANODENKAPPE M. HOCHSPG.-KABEL                | C.R.T. SOCKET                                  |
| 0028.000             |                      | 29631-816.01              | 2            | GEBERHALTERUNG                               | REMOTE CONTROL HOLDER                          |
| 0029.000             |                      | 29633-375.06              |              | NETZTASTE                                    | POWER KEY                                      |
| 0030.000             | △                    | 8290-991-316              |              | NETZKABEL KPL                                | POWER CABLE CPL GWN9.22                        |
| 0031.000             | △                    | 29642-059.06              |              | TELEPILOT TP 720                             | REMOTE CONTROL TP 720                          |
|                      |                      | 28305-122.08              | X            | BILDROHRPLATTE                               | PICTURE TUBE BOARD                             |
|                      |                      | 72010-016.80              |              | SERVICE MANUAL                               | SERVICE MANUAL                                 |
|                      |                      | 21416-941.01              |              | BEDIENUNGSANLEITUNG                          | INSTRUCTION MANUAL                             |
|                      |                      | 29701-093.07              | X            | CHASSIS-FS-STEREO<br>CUC 7350<br>KEIN E-TEIL | CHASSIS-TV-STEREO<br>CUC 7350<br>NO SPARE PART |
|                      |                      |                           |              | X = SIEHE GESONDERTE E-LISTE                 | X = SEE SEPARATE PARTS LIST                    |

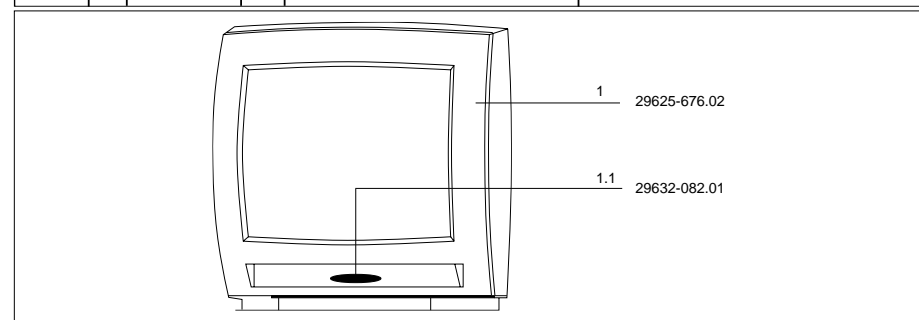

Es gelten die Vorschriften und Sicherheitshinweise gemäß dem Service Manual "Sicherheit", Sach-Nummer 72010-800.00, sowie zusätzlich die eventuell abweichenden, landesspezifischen Vorschriften!



The regulations and safety instructions shall be valid as provided by the "Safety" Service Manual, part number 72010-800.00, as well as the respective national deviations.